

JAFICH & ASOCIADOS



1



Mayores informes
844 4152535
ventas@jtafich.com.mx



CATÁLOGO 2022
ARTÍCULOS PROMOCIONALES



Acabado
Rubber



DIEGO

T 76 Huichol

Termo de acero inoxidable con doble pared insulated al vacío, incluye un filtro infusor y acabado rubber. EDICIÓN HUICHOL. Cap. 500 ml.

- MT Acero Inoxidable
- M 6.5 x 23.5 cm
- E 50 Pzas
- MI 6 x 6 cm
- TI Serigrafía / Tampografía / Láser

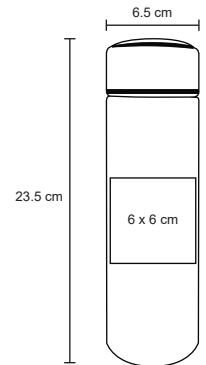

*Hola:
Soy Colosio de la Rosa,
integrante de un grupo de
más de 10 artesanos de la
Sierra de Jalisco, realizamos
Arte Huichol desde hace 21
años, para no perder la
tradición, nuestro dialecto y
cultura.
Gracias por apoyarnos
comprando estos productos
que realizamos con mucho
carino y esfuerzo.*

TAMAYO

T 116 Huichol

Termo con doble pared de vidrio, infusor de metal y tapa enrollable de bambú. EDICIÓN HUICHOL. Cap. 420 ml.

- MT Vidrio / madera
- M 7 x 22.5 cm
- E 30 Pzas
- MI 9 x 13 cm
- TI Serigrafía / Tampografía

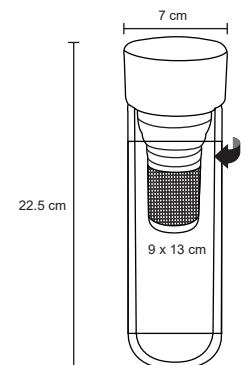

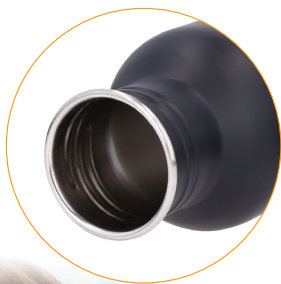
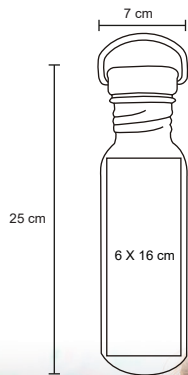

SIQUEIROS

T 53 Huichol

Cilindro de acero inoxidable con detalle de bambú en tapa. EDICIÓN HUICHOL. Cap. 750 ml.

MT Acero Inoxidable M 7 x 25 cm E 60 Pzas

MI 6 x 16 cm TI Serigrafía / Tampografía / Láser



HECHO POR ARTESANOS MEXICANOS

FRIDA

HO 026 Huichol

Taza de cerámica con acabado mate y tapa de bambú. Incluye cuchara de acero inoxidable. EDICIÓN HUICHOL. Cap. 450 ml.

MT Cerámica M 8 x 9 cm E 48 Pzas MI 4 x 3.5 cm TI Serigrafía / Tampografía

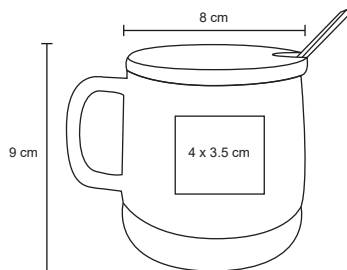



TOLEDO

T 42 Huichol

Set de licorera que incluye 2 vasos metálicos, embudo y caja de regalo. EDICIÓN HUICHOL.
Cap. 8 Oz.

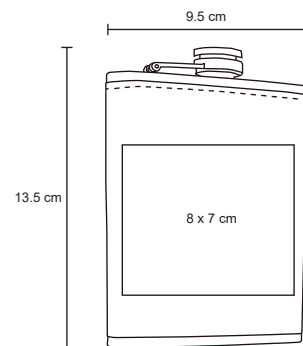

MT Acero Inoxidable / Curpiel
 M 9.5 x 13.5 cm
 E 30 Pzas
 MI 8 x 7 cm
 TI Grabado bajo relieve / Láser
 Serigrafía / Tampografía



HECHO POR ARTESANOS MEXICANOS

RULFO

O 020 Huichol

Set de vino con sacacorcho, boquilla, corcho metálico, corta gotas y termómetro. EDICIÓN HUICHOL.



MT Madera / Metal
 M 18 x 18.5 cm
 E 30 Pzas
 MI 7 x 7 cm
 TI Serigrafía / Tampografía / Láser

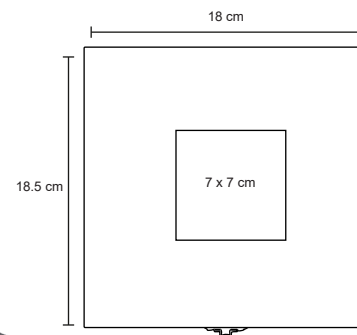

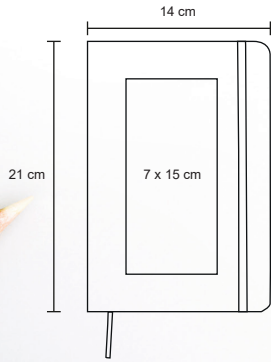

SABINES

O 006 Huichol

Libreta de poliuretano con 90 hojas de raya. EDICIÓN HUICHOL.

MT Poliuretano

M 14 x 21 cm

E 78 Pzas

MI 7 x 15 cm

TI Grabado bajo relieve / Serigrafía
Tampografía / Láser

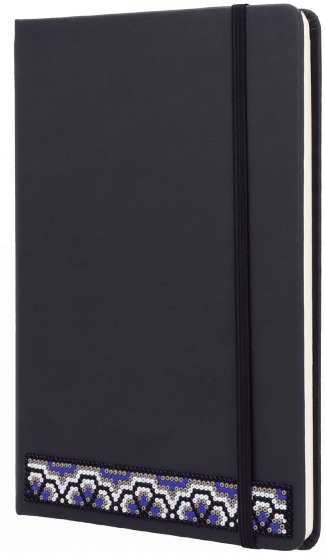

HECHO POR ARTESANOS MEXICANOS



CISNEROS

FM 930 Huichol

Bolígrafo de fibra de carbono con tapa metálica. Incluye estuche. EDICIÓN HUICHOL.

MT Fibra de carbono / metal

M 12 x 14 cm

E 100 Pzas

MI 1 x 3.5 cm

TI Serigrafía / Tampografía / Láser

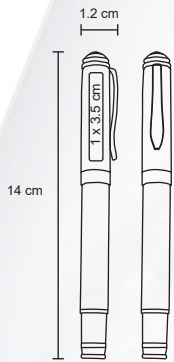



TURCO

T 139

Termo con doble pared de acero inoxidable insulated al vacío. Acabado rugoso y tapa de rosca con asa que se utiliza como taza. Cap. 500 ml.

MT Acero Inoxidable M 6.5 x 24 cm E 50 Pzas

MI 5 x 13 cm 3 x 3 cm TI Serigrafía / Tampografía / Láser

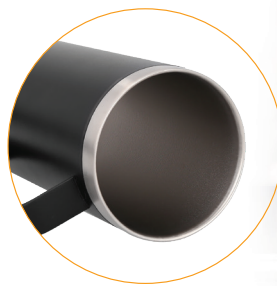

KING

T 138

Termo con doble pared de acero inoxidable insulated al vacío. Incluye una tapa transparente de cierre a presión con seguro deslizable, asa y un acabado rugoso. Cap. 620 ml.

MT Acero inoxidable / plástico M 7 x 20.5 cm E 30 Pzas

MI 6 x 16 cm TI Serigrafía / Tampografía / Láser

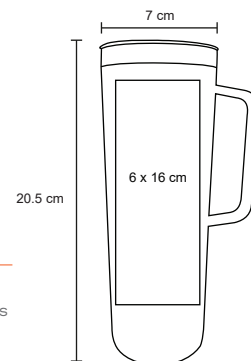

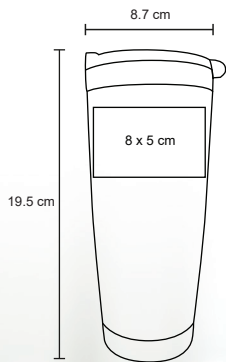
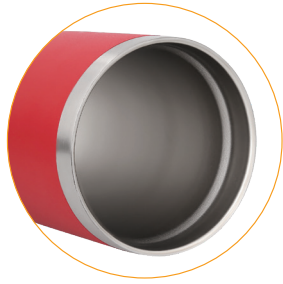

AFFOGATO

T 137

Termo con doble pared de acero inoxidable aislado al vacío. Incluye tapa transparente de cierre a presión y acabado rugoso. Cap. 550 ml.

- MT** Acero inoxidable / plástico
- M** 8,7 x 19,5 cm
- E** 60 Pzas
- MI** 8 x 5 cm
- TI** Serigrafía / Tampografía / Láser





EVEREST

T 141

Termo con doble pared de acero inoxidable, insulado al vacío y acabado mate. Incluye filtro infusor y tapa enroscable. Cap. 800 ml.

- MT Acero Inoxidable
- M 8 x 23,5 cm
- E 40 Pzas
- MI 7 x 15 cm
- TI Láser / Serigrafía / Tampografía



23,5 cm

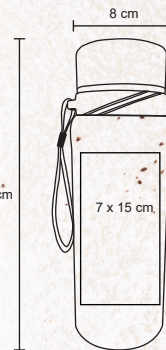

SWISS

T 143

Termo con doble pared de acero inoxidable insulado vacío, tapa de plástico enroscable y boquilla de seguridad. Cap. 500 ml.

- MT Acero inoxidable
- M 6,8 x 20,5 cm
- E 50 Pzas
- MI 6 x 10 cm
- TI Láser / Serigrafía / Tampografía



20,5 cm

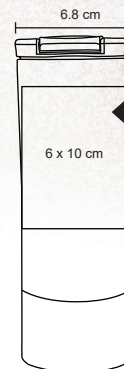

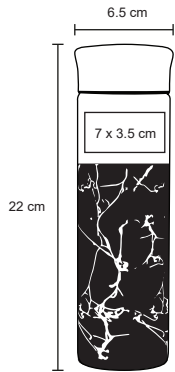

QATAR

T 144

Termo con doble pared de acero inoxidable insulated al vacío. Incluye filtro infusor y termómetro digital que mide la temperatura de sus bebidas. Cap. 500 ml.

MT Acero inoxidable
 M 6.5 x 22 cm
 E 60 Pzas
 MI 7 x 3.5 cm
 TI Serigrafía / Láser Tampografía



BAZUCA

T 140

Termo con doble pared de acero inoxidable insulated al vacío. Incluye tapa de rosca que se utiliza como taza y una cinta ajustable para sujetarlo. Cap. 800 ml.

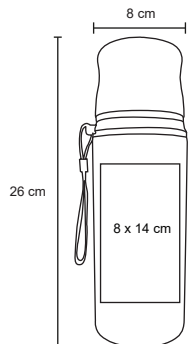

MT Acero inoxidable
 M 8 x 26 cm
 E 40 Pzas
MI 8 x 14 cm
TI Serigrafía / Tampografía / Láser



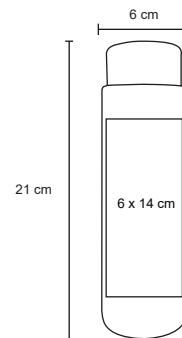

CARAMEL

T 142

Termo con doble pared de acero inoxidable insulated al vacío con acabado rugoso. Incluye filtro infusor y tapa enroscable. Cap. 400 ml.

- MT Acero inoxidable
- M 6 x 21 cm
- E 60 Pzas
- MI 6 x 14 cm
- TI Láser / Serigrafía / Tampografía



ESPRESSO

T 146

Termo con doble pared de acero inoxidable insulated al vacío. Incluye tapa de cierre a presión. Cap. 550 ml.

- MT Acero inoxidable / plástico
- M 9 x 17.5 cm
- E 50 Pzas
- MI 6 x 5 cm
- TI Láser / Serigrafía / Tampografía

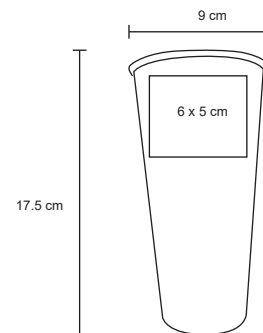

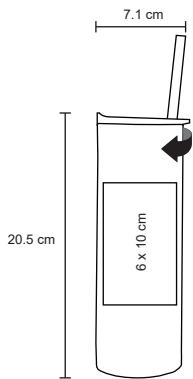

MOSCATO

T 150

Termo con doble pared de acero inoxidable insulated al vacío. Incluye tapa de plástico a presión con boquilla deslizable y popote de plástico. Cap. 610 ml.

MT Acero inoxidable / plástico
 M 7.1 x 20.5 cm
 E 50 Pzas
 MI 6 x 10 cm
 TI Serigrafía / Tampografía Láser



CEDRO

T 156

Termo con doble pared de acero inoxidable insulated al vacío. Incluye tapa enroscable y filtro infusor. Acabado tipo madera. Cap. 500 ml.

MT Acero inoxidable
 M 6.5 x 23.5 cm
 E 50 Pzas
 MI 6 x 6 cm
 TI Serigrafía / Tampografía / Láser



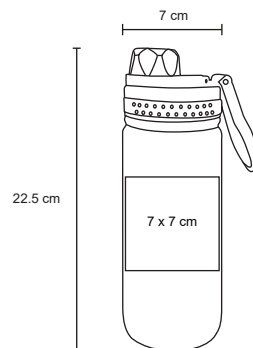
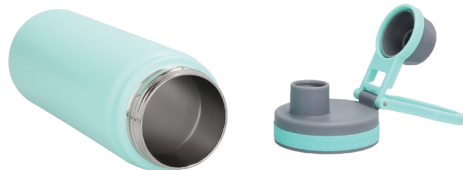

SUGAR

T 157

Termo con doble pared de acero inoxidable insulated al vacío con acabado rugoso. Cuenta con una tapa de rosca con asa para sujetarlo fácilmente. Cap. 530 ml.

MT Acero inoxidable
 M 7 x 22.5 cm
 E 50 Pzas
 MI 7 x 7 cm
 TI Láser / Serigrafía / Tampografía



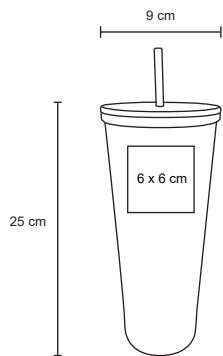

BREW

T 158

Termo de acero inoxidable con doble pared insulado al vacío. Incluye popote metálico. Cap. 675 ml.

MT Acero inoxidable
 M 9 x 25 cm
 E 50 Pzas
 MI 6 x 6 cm
 TI Láser / Serigrafía / Tampografía





HIMALAYA

T 151

Termo con doble pared de acero inoxidable insulated al vacío con acabado rugoso. Incluye tapa transparente de cierre a presión. Cap. 500 ml.

MT Acero inoxidable
 M 8.7 x 17.5 cm
 E 24 Pzas
 MI 6 x 5.5 cm
 TI Láser / Serigrafía Tampografía

COFFEE

T 145

Taza con doble pared de acero inoxidable e interior de plástico. Incluye tapa transparente de cierre a presión con seguro deslizable. Cap. 450 ml.

MT Acero inoxidable / Plástico
 M 8.5 x 12 cm
 E 36 Pzas
 MI 7 x 7 cm
 TI Láser / Serigrafía Tampografía



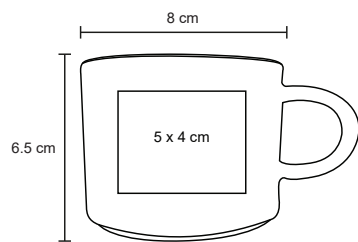

CAPUCCINO

HO 054

Taza de cerámica con cuchara de acero inoxidable para sujeción en el borde. Cap. 220 ml.

MT Cerámica / metal
 M 8 x 6.5 cm
 E 36 Pzas
 MI 5 x 4 cm
 TI Tampografía

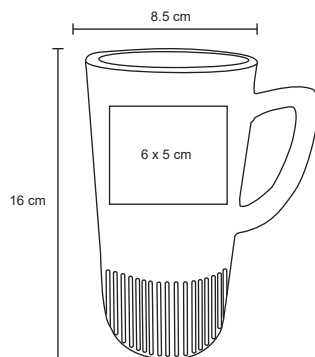

MIRO

HO 056

Taza cónica de cerámica. Cap. 520 ml.

MT Cerámica
 M 8.5 x 16 cm
 E 48 Pzas
MI 6 x 5 cm
TI Tampografía / Serigrafía





Acabado
Rubber

AIREN

T 147

Termo con doble pared de acero inoxidable y acabado rubber. Incluye tapa transparente de cierre a presión. Cap. 300 ml.

MI Acero inoxidable / plástico M 8 x 12 cm E 30 Pzas

MI 6 x 5 cm TI Láser / Serigrafía / Tampografía

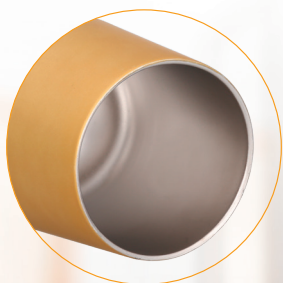
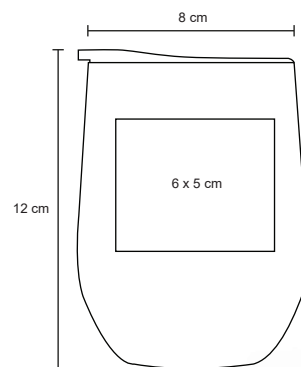

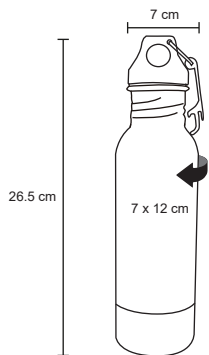

CHELA

T 136

Termo porta cervezas de acero inoxidable, con tapa de plástico enroscable, destapador metálico con arillo, base giratoria y funda de neopreno. Únicamente para botellas de cerveza de 355 ml.



MT Acero inoxidable
 M 7 x 26 cm
 E 30 Pzas
 MI 7 x 12 cm
 TI Láser / Serigrafía / Tampografía

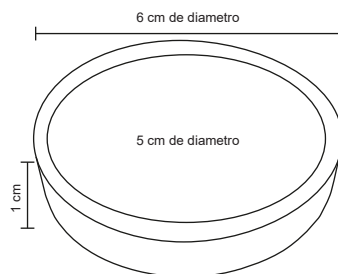

PORTER

BO 001

Destapador de madera.

MT Madera
 M Diámetro: 6 cm
 E 500 Pzas
 MI 6 x 5 cm
 TI Láser / Serigrafía / Tampografía



STELLA

T 154

Termo de plástico con doble pared y tapa enroscable con seguro deslizable. Cap. 540 ml.

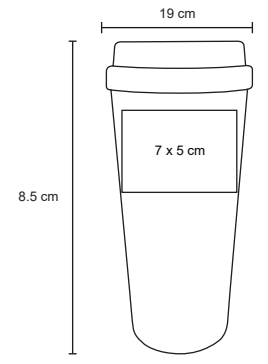

- MT Plástico
- M 19 x 8.5 cm
- E 50 Pzas
- MI 7 x 5 cm
- TI Serigrafía / Tampografía



SUNRISE

T 153

Vaso de color traslúcido. Cap. 355ml.



- MT Plástico
- M 6.7x13 cm
- E 50 Pzas
- MI 7 x 4 cm
- TI Serigrafía / Tampografía

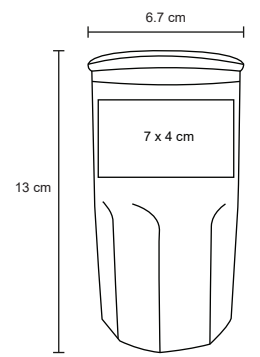



LUKA

T 152

Cilindro de plástico de color traslúcido con tapa enrosacable y chupón para evitar derrames. Cap. 940 ml.

MT Plástico
 M 7.5 x 26 cm
 E 120 Pzas
 MI 8 x 16 cm
 TI Serigrafía

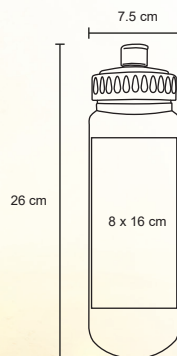



HOT

12 Oz

Vaso desechable para bebidas calientes. Cap. 12 Oz.



- MT Cartón
- M 9 x 10.5 cm
- E 1000 Pzas
- MI 5 x 5 cm
- TI Serigrafía



HOT

16 Oz

Vaso desechable para bebidas calientes. Cap. 16 Oz.

- MT Cartón
- M 9 x 13.6 cm
- E 1000 Pzas
- MI 6 x 6 cm
- TI Serigrafía



HOT

20 Oz

Vaso desechable para bebidas calientes. Cap. 20 Oz.



- MT Cartón
- M 9 x 16.4 cm
- E 1000 Pzas
- MI 7 x 7 cm
- TI Serigrafía

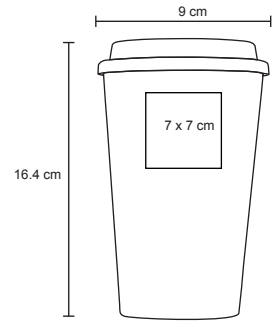

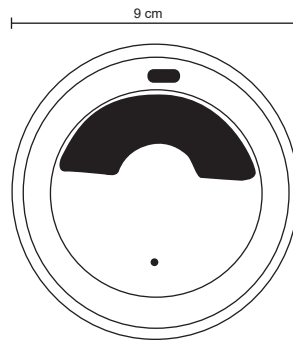

HOT TAPA

Tapa plástica para vaso desechable.

MT Plástico M Diámetro: 9 cm E 1000 Pzas

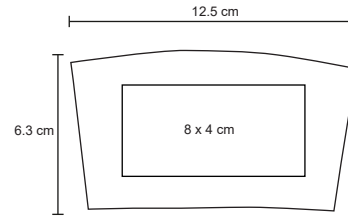

HOT MANGA

Fajilla de cartón para vaso desechable.

MT Cartón M 12.5 X 6.3 cm E 1200 Pzas
MI 8 x 4 cm TI Serigrafía / Tampografía

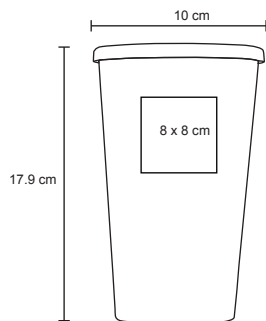

COLD 32 OZ

Vaso desechable para bebidas fría. Cap. 32 Oz.

MT Cartón M 10 x 17.9 cm E 1000 Pzas
MI 8 x 8 cm TI Serigrafía





NFC

NP 21003



Bolígrafo con etiqueta NFC integrada que puede contener un enlace y es compatible con todos los teléfonos inteligentes NFC.

- MT Plástico
- M 11 x 14.2 cm
- E 1000 Pzas
- MI 1 x 5 cm
- TI Serigrafía / Tampografía

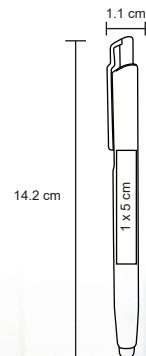

SHELBY

BP 17121R



Bolígrafo de plástico con acabado rubber.

- MT Plástico
- M 1 x 14 cm
- E 1000 Pzas
- MI 0.8 x 5 cm
- TI Serigrafía / Tampografía

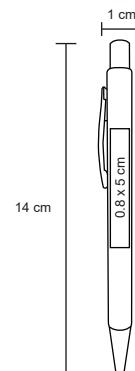

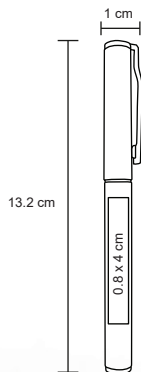

COBRA

LR 31001

Bolígrafo de plástico con tinta de gel, tapa traslúcida y clip de plástico.

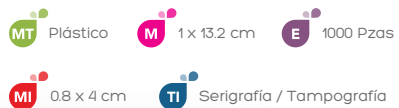

La tinta rinde hasta 1500 mts.

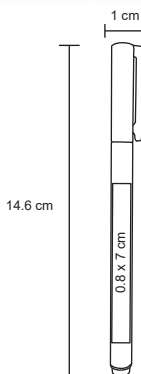

DEMON

GL 20160

Bolígrafo de plástico con tinta de gel, tapa traslúcida y clip de plástico.

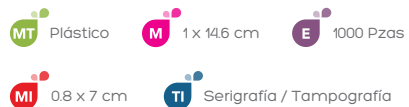

La tinta rinde hasta 1500 mts.





GEL SP 2001A

Bolígrafo de plástico. Incluye gel antibacterial en spray.

- MT** Plástico / Gel antibacterial
- M** 12 x 15.7 cm
- E** 1000 Pzas
- MI** 1 x 5 cm
- TI** Serigrafía / Tampografía

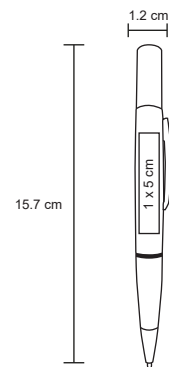

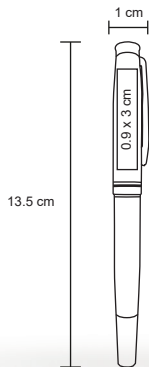

WILDE PT 20230

Bolígrafo metálico con acabado rubber.
Incluye tapa y estuche.

- MT Aluminio
- M 1 x 13.5 cm
- E 100 Pzas
- MI 0.9 x 3 cm
- TI Serigrafía / Tampografía / Láser

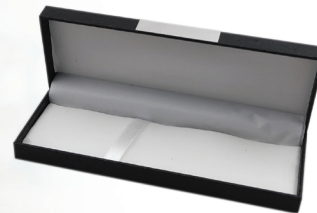

KAFKA PT 1518-1

Bolígrafo metálico con acabado rubber.
Incluye tapa y estuche.

- MT Aluminio
- M 1.2 x 14.3 cm
- E 100 Pzas
- MI 0.9 x 4 cm
- TI Serigrafía / Tampografía / Láser

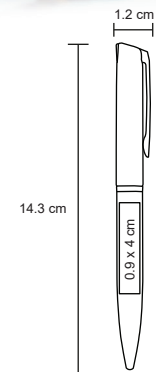



XELHA

BL 094

Bolsa de yute con interior laminado y fuelle de 18 cm. Cuenta con un par de asas y un botón para cierre.

- MT Yute
- M 46 x 34 cm
- E 100 Pzas
- MI 28 x 21 cm
- TI Bordado / Serigrafía

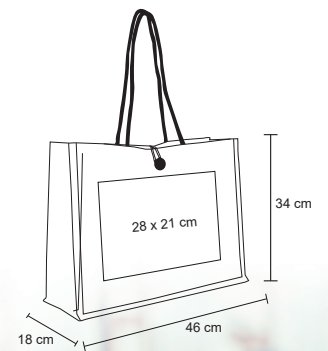

KRAFT

BL 091

Bolsa ecológica de cartón laminado con asa de algodón y fuelle de 10 cm. Resistente al agua.

- MT Kraft laminado
- M 30 x 30 cm
- E 150 Pzas
- MI 23 x 21 cm
- TI Serigrafía

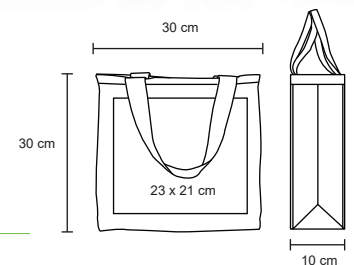

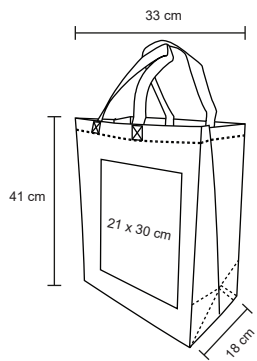

ATLANTIS

BL 092

Bolsa ecológica termosellada con fuelle de 18 cm y asa.



MT Non Woven
M 33 x 41 cm
E 200 Pzas
MI 21 x 30 cm
TI Serigrafía

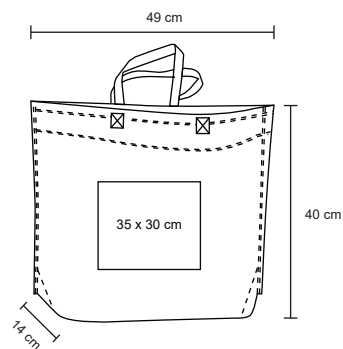

MEDITERREAN

BL 093

Bolsa ecológica termosellada con asa y un fuelle en la base de 14 cm.



MT Non Woven
M 49 x 40 cm
E 200 Pzas
MI 35 x 30 cm
TI Serigrafía





SAFIRE PLUS

BL 099

Mochila con tejido resistente al agua, compartimento acolchado para laptop de 15,6", correas de hombro ajustables, bolsillo frontal de acceso rápido, asa de transporte superior, bolsillo lateral de malla y un fuelle de 11.96 cm.



- MT Poliéster
- M 32.51 x 46.48 x 11.96 cm
- E 5 Pzas
- MI 10 x 4 cm
- TI Serigrafía

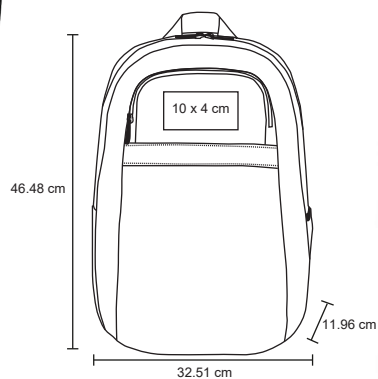



360°



SPORT BACKPACK

BL 100

Mochila deportiva; incluye compartimento exclusivo para laptop, correas de hombro ajustables, compartimento secundario para archivos, carpetas, etc. Bolsillo frontal para accesorios, dos bolsillos de acceso rápido, bolsillos laterales y un fuelle de 13.28 cm.

MT Poliéster

M 31.06 x 45.11 x 13.28 cm

E 20 Pzas

MI 10 x 10 cm

TI Serigrafía



INTELLECT ADVANCED

BL 101

Mochila de diseño liviano, incluye compartimento exclusivo para laptop, panel trasero de malla, correas de hombro ajustables y contorneadas. Compartimento secundario para archivos, carpetas, etc. Bolsillo frontal para accesorios, dos bolsillos de acceso rápido, dos bolsillos laterales y un fuelle de 11.43 cm.



360°



MT Poliéster

M 42.47 x 30.96 x 11.43 cm

E 5 Pzas

MI 10 x 10 cm

TI Serigrafía

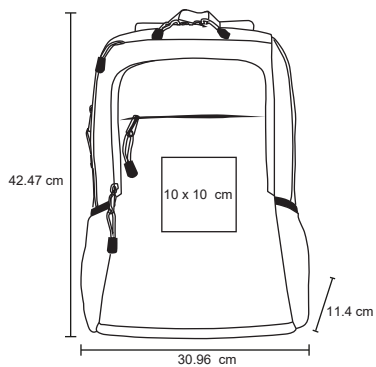



TORETTO

BL 096

Mochila con salida USB (se requiere conectar a batería portátil), con correas ajustables acojinadas y asa. Cuenta con 7 compartimentos: compartimento interno para laptop, compartimento principal, compartimento interno para power bank, 2 bolsas frontales y 2 compartimentos laterales. Fuelle de 14 cm.

MT Poliéster
 M 29 x 45 cm
 E 50 Pzas
 MI 15 x 10 cm
 TI Serigrafía



LEBRON

BL 098



Maleta deportiva que se convierte en mochila, con 2 broches de seguridad ajustables y tirantes acolchonados. Incluye zapatera y dos compartimentos exteriores, asas y correa ajustable. Fuelle de 14 cm.

MT Poliéster
 M 52 x 28 cm
 E 25 Pzas
 MI 15 x 10 cm
 TI Serigrafía / Bordado

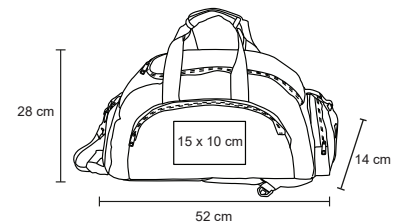



360°

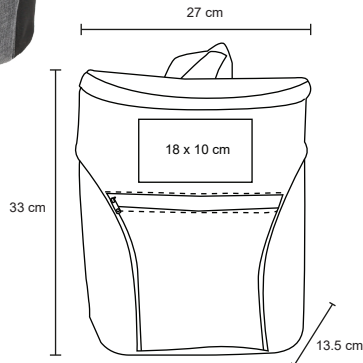

ALASKA

LON 016

Hielera back pack con interior plastificado sellado. Cuenta con dos compartimentos con cierre, correas ajustables, asa y un fuelle de 13.5 cm.

MT Poliéster

M 27 x 33 cm

E 30 Pzas

MI 18 x 10 cm

TI Serigrafía / Bordado

360°



COOLER

LON 014

Hielera de poliéster con interior impermeable sellado, asas, un compartimento externo al frente y un fuelle de 13 cm.

MT Poliéster

M 26 x 17 cm

E 50 Pzas

MI 10 x 6 cm

TI Serigrafía / Bordado

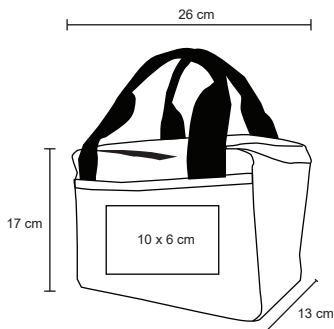



360°



FRIGO

LON 015



Hielera de poliéster con interior térmico, asa, bolsillos laterales de malla, correa para sujetar al hombro, compartimento externo al frente y un fuelle de 15 cm.

- MT Poliéster
- M 24 x 27 cm
- E 50 pzas.
- MI 10 x 6 cm
- TI Serigrafía / Bordado

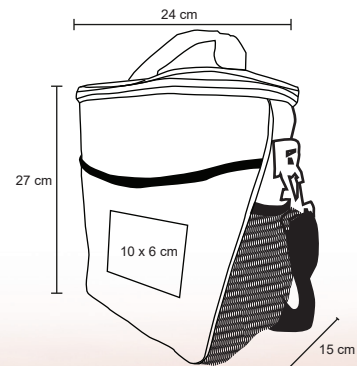

FARAH

LON 017

Lonchera térmica con interior metálico, dos bolsas laterales y asa para transportar. Fuelle de 145 cm.

- MT Poliéster
- M 25.5 x 25 cm
- E 100 Pzas
- MI 20 x 20 cm
- TI Serigrafía



360°

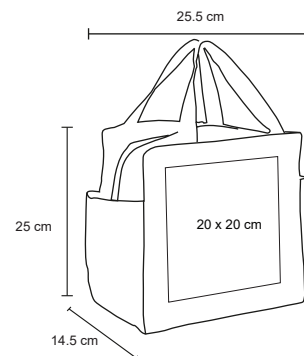

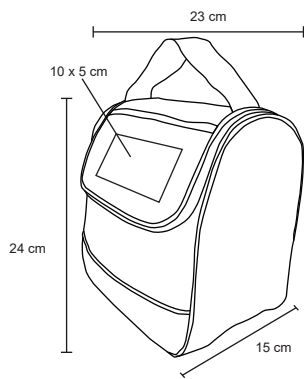

SNACK

LON 012

Lonchera de poliéster con interior impermeable plastificado, cierre, asa y un compartimento externo al frente. Fuelle de 15 cm.

MT Poliéster
 M 23 x 24 cm
 E 40 Pzas
 MI 10 x 5 cm
 TI Serigrafía / Bordado

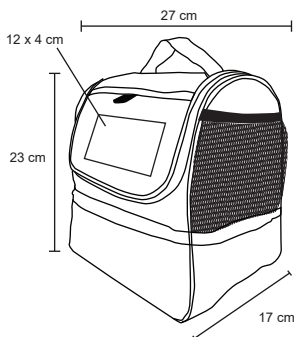

GARDEN

LON 013

Lonchera de poliéster con 2 compartimentos, interior impermeable plastificado, asa, un compartimento externo al frente, bolsillo lateral de malla y fuelle de 17 cm.

MT Poliéster
 M 27 x 23 cm
 E 35 Pzas
 MI 12 x 4 cm
 TI Serigrafía / Bordado





ARMY

BL 102

Gorra de poliéster con ajuste elástico.

- MT Poliéster
- M Diámetro 17 cm
- E 140 Pzas
- MI 5 x 5 cm
- TI Serigrafía / Bordado

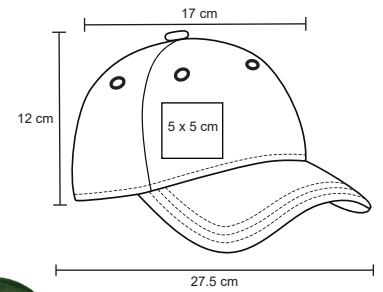

DOMINIC

BL 095

Cangurera deportiva con 3 compartimentos (2 delanteros y uno trasero) y cinturón ajustable.

- MT Poliéster
- M 36 x 16 cm
- E 200 Pzas
- MI 10 x 4 cm
- TI Serigrafía / Bordado

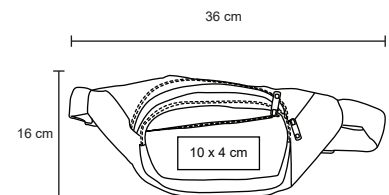

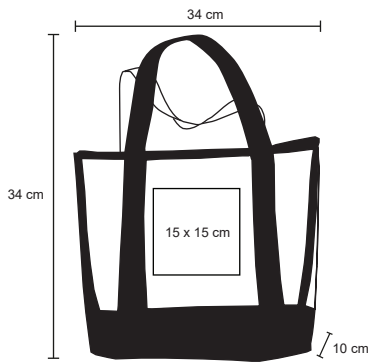

PARAISO

BL 097

Bolsa plástica transparente con asas y base de poliéster.
Fuelle de 10 cm.



MT PVC M 34 x 34 cm E 60 Pzas MI 15 x 15 cm TI Serigrafía



FASHION

CP 064

Cosmetiquera con acabado glitter, cierre y correa de plástico intercambiable. Fuelle de 7 cm.

MT Poliéster M 18 x 10 cm E 300 Pzas MI 10 x 5 cm TI Serigrafía

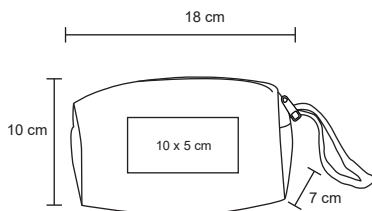



WANDA

CP 062

Cosmetiquera rectangular de poliuretano, con 5 separadores para brochas y un resorte. Cuenta con forro interno, asa y dos cierres. Fuelle de 13 cm.

360°



MT Poliuretano
 M 22 x 11 cm
 E 100 Pzas
 MI 15 x 6 cm
 TI Serigrafía / Grabado bajo relieve

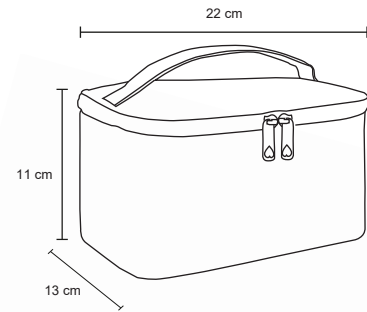

SECRET

CP 063

Cosmetiquera con forro. Cuenta con cierre superior y dos compartimentos interiores de malla. Fuelle de 8 cm.

360°



MT Poliuretano
 M 23.5 x 15 cm
 E 100 Pzas
MI 13 x 10 cm
 TI Serigrafía / Grabado bajo relieve

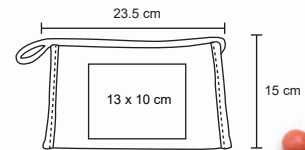

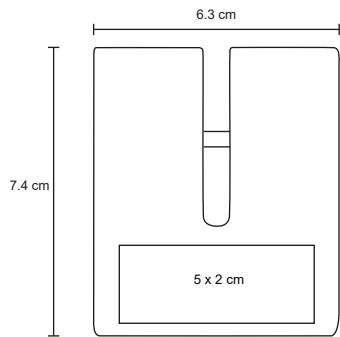

TAOS

SO 089

SopORTE metálico para celular.

MT Aluminio
 M 6.3 x 7.4 cm
 E 200 Pzas
 MI 5 x 2 cm
 TI Tampografía / Láser

MOON

SO 088

Sujetador de auto para dispositivos móviles. Incluye imán que se adhiere a la parte trasera del móvil.

MT Plástico / imán
 M 2.5 x 6 x 3 cm
 E 200 Pzas
MI 2 x 1 cm
TI Tampografía / Serigrafía

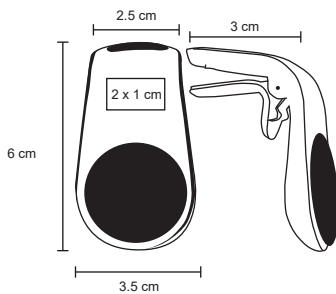



MORAT

SO 092

Audífonos bluetooth con botón de encendido/ apagado y mecanismo touch. Incluye estuche de aluminio recargable, gomas de repuesto y cable de carga. Cap. 1000 mAh.

- MT Plástico / Aluminio
- M 9.6 x 3 cm
- E 100 Pzas
- MI 3 x 15 cm
2.5 diámetro
- TI Tampografía / Láser

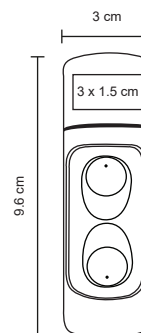

BALVIN

SO 091

Auriculares bluetooth con función de manos libres. Audífonos acolchonados. Tiempo de carga: 1 hr. Duración de uso: 7 hrs. Alcance de operación: 10 m. Incluye cable de carga, botón multifuncional, reducción de sonido. Función de emparejamiento múltiple.

- MT Plástico / Poliuretano
- M 16.5 x 18 cm
- E 60 Pzas
- MI 5.5 diámetro
7 cm
- TI Tampografía / Láser

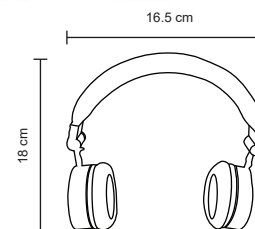

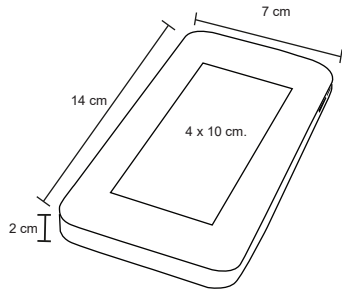

FLAT

SO 093

Power bank portátil. Incluye cable de carga para dispositivos con entrada micro USB, V8, tipo c y tipo lightning. Cap. 8,000 mAh



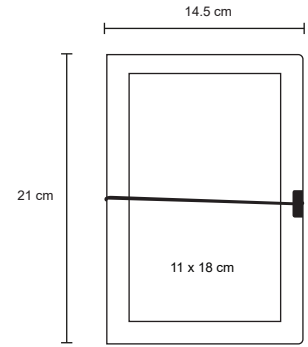
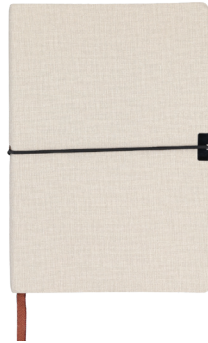

PRADA

O 090

Libreta de poliuretano con pasta texturizada, 96 hojas rayadas, resorte a la mitad y separador.



Poliuretano



14.5 x 21 cm



100 Pzas



11 x 18 cm



Tampografía / Serigrafía / Láser Grabado bajo relieve



LUPIN

O 091

Carpeta multiusos con exterior de poliéster, broche y compartimento externo para bolígrafo. Cuenta con block de notas tamaño carta de 30 hojas rayadas, cintas elásticas para sujetar Smartphones y memorias USB u otros accesorios, compartimento con ventana plástica para credenciales, divisiones para tarjetas y bolsa de malla.



Poliéster / Poliuretano



25 x 32 cm



50 Pzas



10 x 10 cm



Serigrafía / Grabado bajo relieve

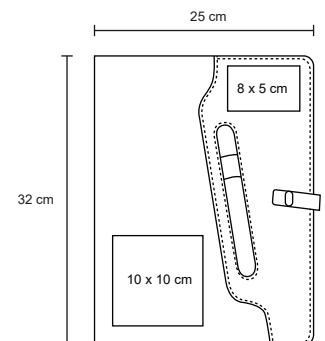

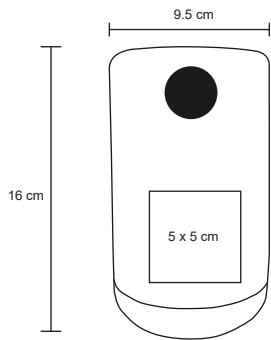

VITALI

HO 053

Humidificador de aire con función de luz de noche e indicador de carga. Incluye cable de carga. Cap. 500 ml.



WALDORF

HO 064

Portarretratos de cristal con soporte plegable.

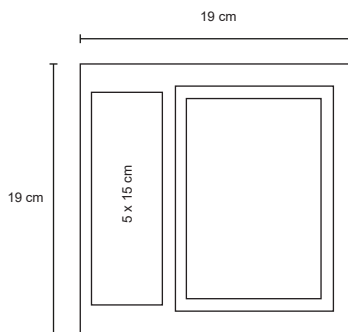
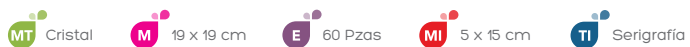



BARMAN

HO 059

Set de coctelería. Incluye 9 accesorios: funda, shaker, medidor, cucharilla, mortero, destapador, pinzas y colador / mezclador.

MT Acero inoxidable M 40 x 32.5 cm E 20 Pzas

MI 5 x 2 cm TI Tampografía / Serigrafía / Láser

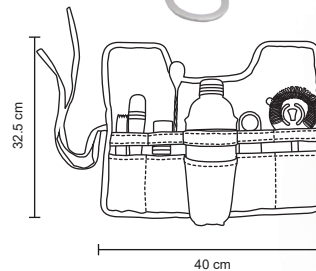

MOJITO

HO 060

Set para preparación de bebidas. Incluye: shaker, pinzas, medidor, popote con cucharilla incluida y colador/mezclador.

MT Acero inoxidable M 25 x 29 x 9 cm E 12 Pzas

MI 20 x 20 cm TI Caja: Serigrafía Shaker: Láser / Tampografía

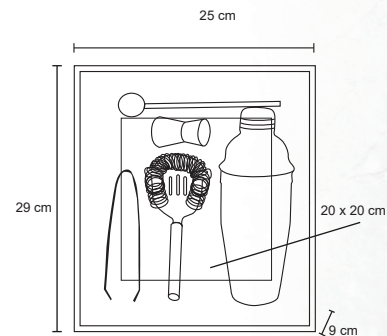

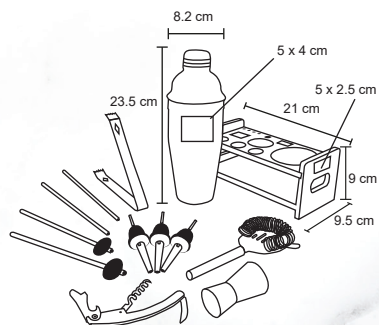

DAIQUIRI

HO 052

Set para preparación de bebidas con base de madera. Incluye 12 piezas: shaker con colador y tapa, pinzas, sacacorchos, dosificador, 4 popotes (dos rectos y dos con cucharilla incluida), colador/ mezclador y 3 vertedores. Cap. 710 ml.

MT Acero inoxidable / madera

M Base: 21 x 9 x 9.5 cm
Shaker: 8.2 x 23.5 cm

E 15 Pzas

MI Base: 5 x 2.5 cm
Shaker: 5 x 4 cm

TI Tampografía / Láser



CARAJILLO

HO 051

Shaker de acero inoxidable y tapa metálica de cierre a presión con coladera. Cap. 550 ml.

MT Acero inoxidable M 8 x 215 cm E 48 Pzas

MI 5 x 2 cm TI Serigrafía / Tampografía / Láser

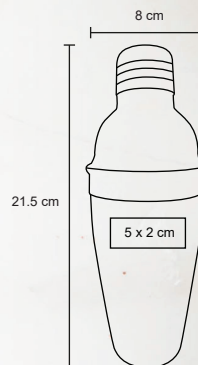

SHOT

T 155

Vaso tequilero de acero inoxidable. Cap. 70 ml.

MT Acero inoxidable M 5 x 6 cm E 516 Pzas MI 3 x 3 cm TI Serigrafía / Tampografía Láser

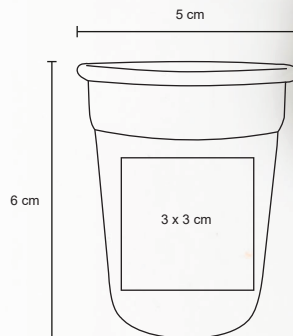



CHEF

HO 055

Utensilios de cocina. Cucharón, cuchara y volteador. No dañan el antiadherente, fáciles de limpiar, no absorben grasas ni sabores. **Se venden por separado.**

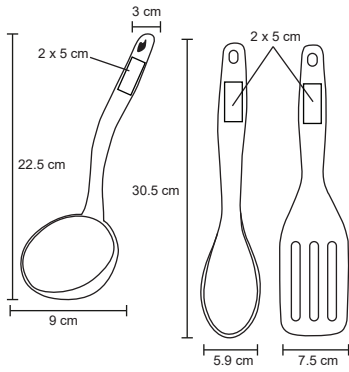

MT Plástico

M Cucharón: 9 x 22 cm
Cuchara: 5.9 x 30.5 cm
Volteador: 7.5 x 30.5 cm

E 150 Pzas

MI 2 x 5 cm

TI Serigrafía / Tampografía

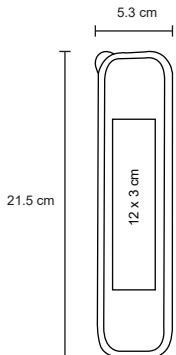

MANI

HO 050

Set de cubiertos de wheat straw (fibra de trigo). Incluye cuchara, tenedor y cuchillo



MT Wheat straw

M 5.3 x 21.5 cm

E 400 Pzas

MI 3 x 12 cm

TI Serigrafía / Tampografía

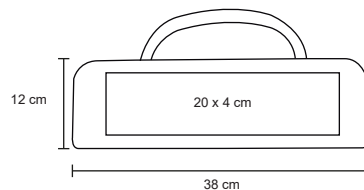

SIRLOIN

HO 061

Set de BBQ en estuche de poliéster. Incluye 3 utensilios: pinzas, tenedor y volteador.

MT Acero inoxidable / M 38 x 12 cm E 24 Pzas MI 20 x 4 cm TI Serigrafía Poliéster



COWBOY

HO 063

Estuche portátil con utensilios para BBQ. Incluye 3 utensilios: pinzas para carne, tenedor y volteador. Fuente: 5 cm.

MT Acero inoxidable / M 49.5 x 13.5 cm E 24 Pzas MI 30 x 7 cm TI Serigrafía

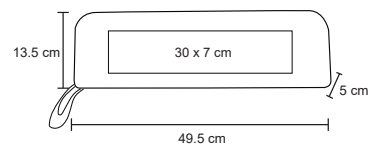

ENTRECOT

HO 062

Set de BBQ en estuche de poliéster y sujetadores de madera. Incluye 4 utensilios: pinzas, tenedor, cuchillo y volteador.



Acero Inoxidable / Madera
Poliéster



38,5 x 15 cm



24 Pzas



20 x 4 cm



Serigrafía

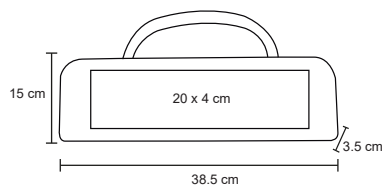



DECAF

HO 057

Prensa francesa con asa de vidrio, base plástica y tapa de acero inoxidable. Cap. 800 ml.

- MT Vidrio / plástico / acero inoxidable
- M 9.8 x 18 cm
- E 12 Pzas
- MI 8 x 7 cm
- TI Serigrafía / Tampografía

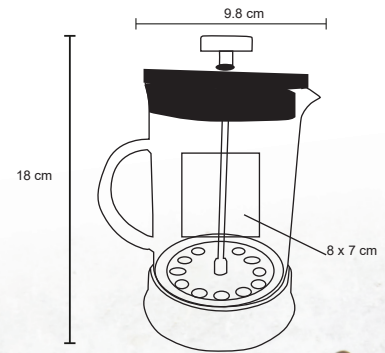

PRESS

HO 058

Prensa francesa de vidrio con base de plástico y tapa de acero inoxidable. Cap. 600 ml.

- MT Vidrio / plástico / acero inoxidable
- M 8.8 x 18.5 cm
- E 24 Pzas
- MI 5 x 4 cm
- TI Serigrafía / Tampografía / Láser

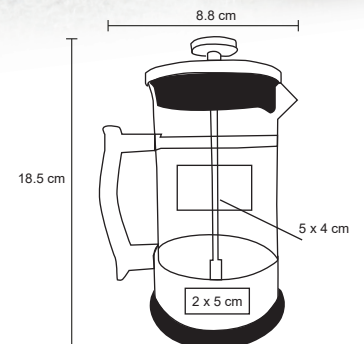

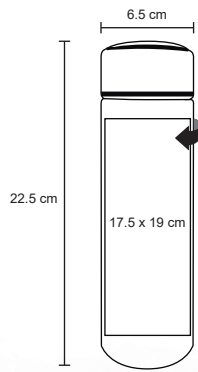

PICASSO

SB 15

Termo sublimable con doble pared de acero inoxidable insulated al vacío. Incluye tapa enroscable y colador integrado para infusión. Cap. 500 ml.

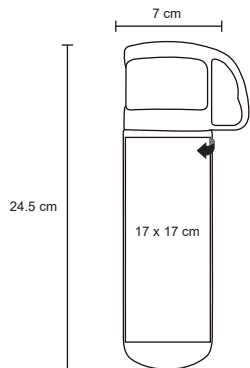

RIVERA

SB 16

Termo sublimable de acero inoxidable insulated al vacío. Incluye tapa que sirve como taza. Cap. 500 ml.



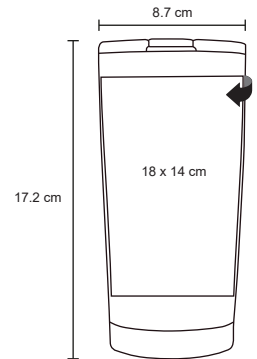
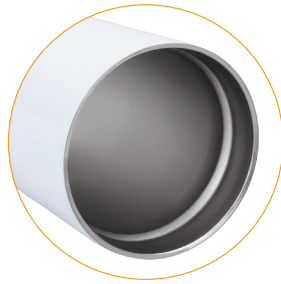

TIZIANO

SB 17

Termo sublimable con doble pared de acero inoxidable aislado al vacío. Incluye tapa de cierre a presión transparente y seguro deslizable. Cap. 520 ml.

MT Acero inoxidable M 8.7 x 17.2 cm E 50 Pzas

MI 18 x 14 cm TI Sublimación

KAHLO

SB 18

Termo sublimable de doble pared de acero inoxidable aislado al vacío. Incluye tapa de cierre a presión transparente con seguro deslizable. Cap. 350 ml.

MT Acero inoxidable M 8 x 11 cm E 50 Pzas MI 18 x 5 cm TI Sublimación

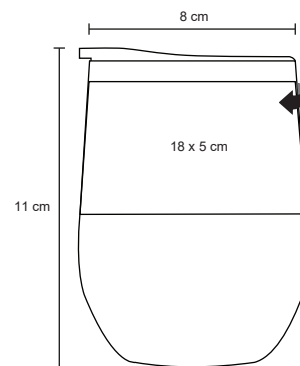

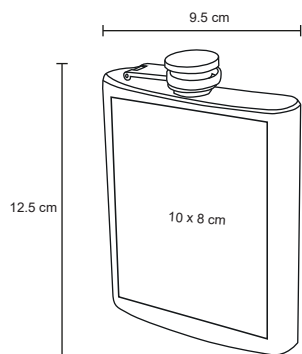

WHISKY

SB 13

Licorera sublimable de acero inoxidable con tapa enrosable. Cap. 8 Oz.

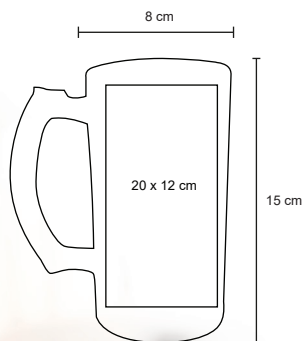

MALTA

SB 14

Tarro cervecero sublimable con acabado Frost. Cap. 465 ml.





CELSIUS

T 117

Termo con doble pared de acero inoxidable con termómetro digital que mide la temperatura de tu bebida, colador metálico y tapa enroscable. Cap. 500 ml. Incluye batería.

- MT Acero inoxidable
- M 6.5 x 22.5 cm
- E 50 Pzas
- MI 7 x 9 cm
- TI Serigrafía / Tampografía / Láser



TARAZÚ

T 76

Termo de doble pared acabado rubber de acero inoxidable, con colador. Cap. 500 ml.

- MT Acero inoxidable
- M 6.5 x 23.5 cm
- E 50 Pzas
- MI 6 x 6 cm
- TI Serigrafía / Tampografía / Láser

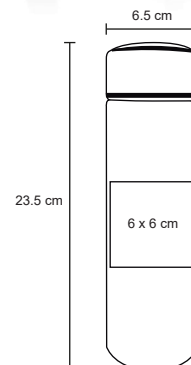

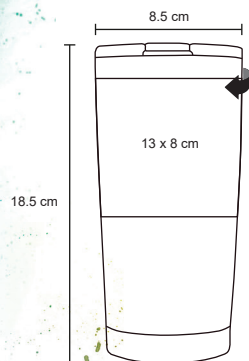

DUVA

T 35

Termo de alta tecnología con doble pared de acero inoxidable que mantiene tus bebidas calientes y frías por más tiempo. Incluye tapa de presión transparente. Cap. 600 ml.

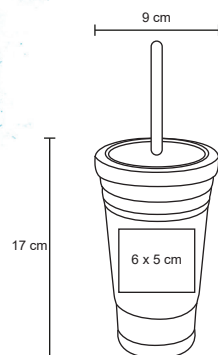

LATTE

T 73

Vaso de acero inoxidable con doble pared. Incluye popote metálico. Cap. 500 ml.

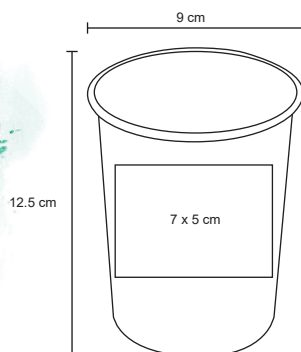

CUP

T 127

Vaso de acero inoxidable. Cap. 480 ml.



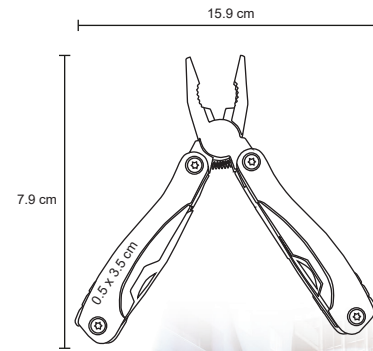

PAGONG

HR 013

Herramienta plegable con 9 funciones: lima, abre latas, doble destapador, sierra, desarmador de cruz, dos desarmadores planos, navaja, pinzas y seguro de bloqueo. Incluye funda.

MT Metal
 M 15.9 x 7.9 cm
 E 120 Pzas.
 MI 0.5 x 3.5 cm
 TI Láser / Tampografía



MILLA

HR 04

Flexómetro con cinta metálica de 5 m. Incluye correa, clip y seguro.

MT Metal / Plástico
 M 6.3 x 7 cm
 E 120 Pzas.
 MI 3 x 3 cm
 TI Serigrafía / Tampografía

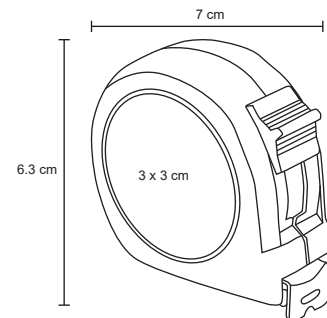

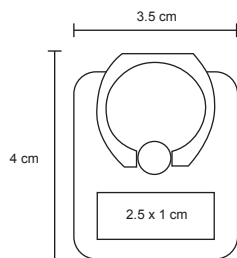

LASH

SO 074

Popsocket rectangular de plástico con anillo metálico.

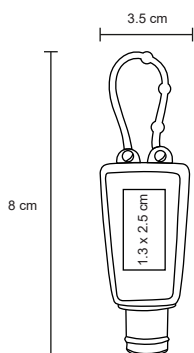

BORA

CP 05

Gel antibacterial en botella con funda de silicón.
Cap. 30 ml.



BEBIDAS





PANDA

NUEVO

T 114

Termo con doble pared de acero inoxidable y exterior de bambú, con colador y tapa metálica enroscable. Cap. 400 ml.

- MT Acero Inox / Bambú
- M 7 x 20.8 cm
- E 50 Pzas
- MI 7 x 10 cm
- TI Tampografía / Láser / Serigrafía

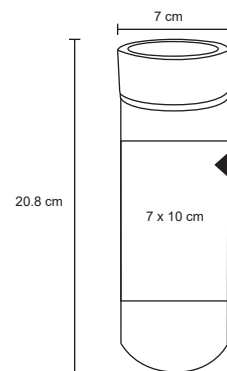

LUNGO

NUEVO

T 118

Termo con doble pared e interior de plástico, exterior de corcho y tapa enroscable. Cap. 470 ml.

- MT Plástico / Corcho
- M 6 x 17 cm
- E 24 Pzas
- MI 6 x 6 cm
- TI Tampografía / Láser / Serigrafía

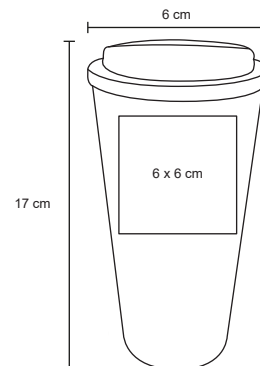

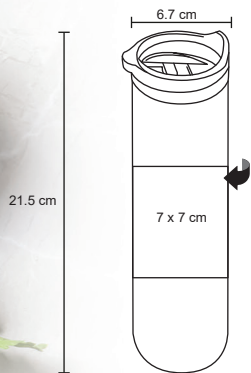

NOGAL

NUEVO

T 121

Termo con doble pared de acero inoxidable, acabado exterior tipo madera, tapa a presión de plástico traslúcida con seguro deslizable y boquilla. Cap. 650 ml.

- MT Acero Inoxidable
- M 6.7 x 21.5 cm
- E 50 Pzas
- MI 7 x 7 cm
- TI Tampografía / Láser / Serigrafía



INFUSIÓN

NUEVO

T 116

Termo con doble pared de vidrio e infusor, colador de metal y tapa enroscable de bambú. Cap. 420 ml.

- MT Vidrio / Bambú
- M 7 x 22.5 cm
- E 50 Pzas
- MI 9 x 13 cm
- TI Tampografía / Serigrafía

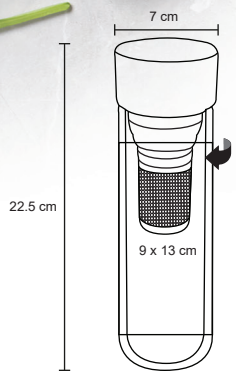



REFLEX

NUEVO

T 112

Termo de alta tecnología con doble pared de acero inoxidable en acabado espejo, que mantiene tus bebidas calientes y frías por más tiempo. Incluye tapa transparente de cierre a presión. Cap. 870 ml.

- MT Acero Inoxidable
- M 10 x 20 cm
- E 20 Pzas
- MI 10 x 8 cm
- TI Tampografía / Láser / Serigrafía

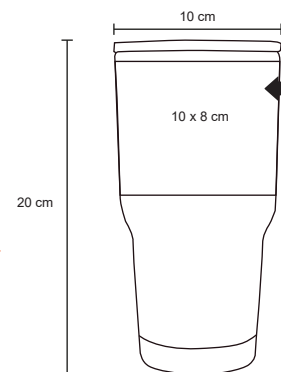

MIRROR

NUEVO

T 113

Termo de alta tecnología con doble pared de acero inoxidable en acabado espejo, que mantiene tus bebidas calientes y frías por más tiempo. Incluye tapa de plástico transparente de cierre a presión. Cap. 500 ml.

- MT Acero Inoxidable
- M 8.5 x 17.5 cm
- E 40 Pzas
- MI 10 x 8 cm
- TI Tampografía / Láser / Serigrafía

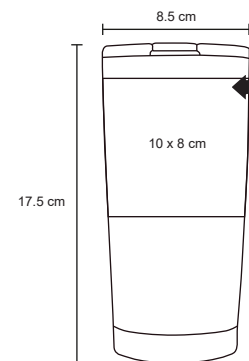

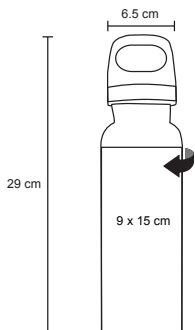

ASTON

NUEVO

T 103

Termo con doble pared de acero inoxidable con tapa de plástico enroscable, con cintillo de silicón y textura en el cuerpo. Cap. 670 ml.

MT Acero Inoxidable

M 65 x 29 cm

E 60 Pzas

MI 9 x 15 cm

TI Tampografía / Láser / Serigrafía



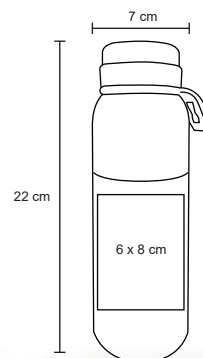

MUMBAI

NUEVO

T 108

Termo con doble pared de acero inoxidable, tapa metálica enroscable, base y asa de silicón. Cap. 500 ml.

- MT Acero Inoxidable
- M 7 x 22 cm
- E 50 Pzas
- MI 6 x 8 cm
- TI Tampografía / Láser / Serigrafía

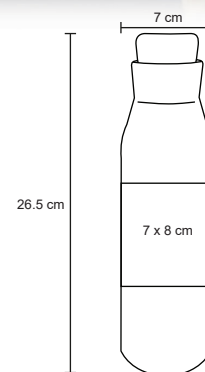

VENTI

NUEVO

T 123

Termo con doble pared de acero inoxidable y tapa metálica enroscable. Cap. 620 ml.

- MT Acero Inoxidable
- M 7 x 26.5 cm
- E 50 Pzas
- MI 7 x 8 cm
- TI Tampografía / Láser / Serigrafía



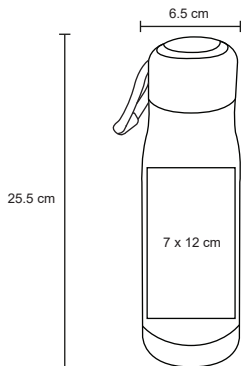

BUGATTI

NUEVO

T 111

Termo con doble pared de acero inoxidable, con tapa plástica enroscable y correa de poliéster. Cap. 550 ml.

- MT Acero Inoxidable
- M 6.5 x 25.5 cm
- E 50 Pzas
- MI 7 x 12 cm
- TI Tampografía / Láser / Serigrafía

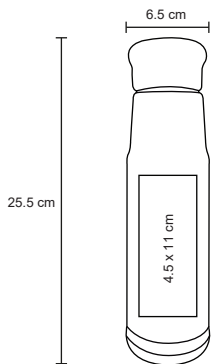

TIBET

T 57

Botella térmica con doble pared de acero inoxidable que mantiene tus bebidas calientes y frías por más tiempo. Con tapa enroscable. Cap. 550 ml.

- MT Acero Inoxidable
- M 6.5 x 25.5 cm
- E 50 Pzas
- MI 4.5 x 11 cm
- TI Serigrafía / Tampografía / Láser



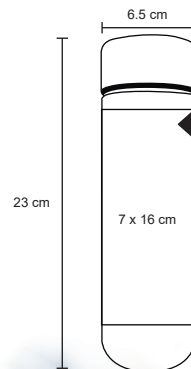

MARFIL

NUEVO

T 106

Termo con doble pared de acero inoxidable con acabado tipo mármol, con colador. Cap. 500 ml.

- MT Acero Inoxidable
- M 6.5 x 23 cm
- E 50 Pzas
- MI 7 x 16 cm
- TI Tampografía / Láser / Serigrafía



CAOBA

T 81

Termo de doble pared de acero inoxidable, terminado rubber, tapa simulación madera con colador. Cap. de 450 ml.

- MT Acero Inoxidable
- M 6.5 x 23 cm
- E 50 Pzas
- MI 5 x 6 cm
- TI Serigrafía / Tampografía / Láser

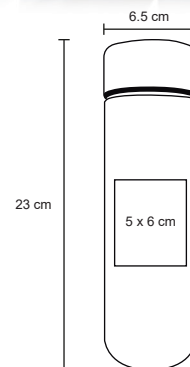

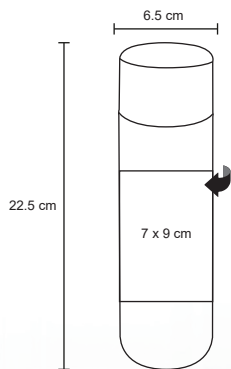

CELSIUS

NUEVO

T 117

Termo con doble pared de acero inoxidable con termómetro digital que mide la temperatura de tu bebida, colador metálico y tapa enroscable. Cap. 500 ml.

MT Acero Inoxidable

M 6.5 x 22.5 cm

E 50 Pzas

MI 7 x 9 cm

TI Tampografía / Láser / Serigrafía



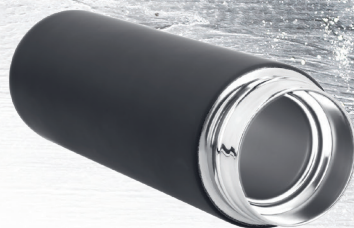

TARAZÚ

T 76

Termo de doble pared de acero inoxidable, acabado rubber y colador.
Cap. de 500 ml

MT Acero Inoxidable
 M 6.5 x 23.5 cm
 E 50 Pzas
 MI 6 x 6 cm
 TI Serigrafía / Tampografía / Láser

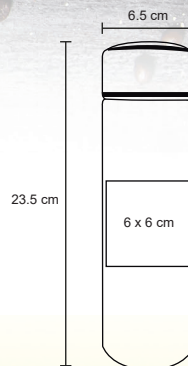

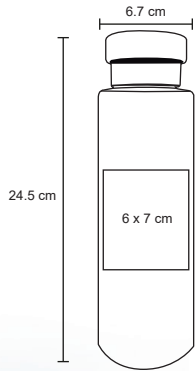

LINCOLN

T 77

Termo de doble pared de acero inoxidable con tapa enroscable. Cap. de 500 ml.

- MT Acero Inoxidable
- M 6.7 x 24.5 cm
- E 40 Pzas
- MI 6 x 7 cm
- TI Serigrafía / Tampografía / Láser

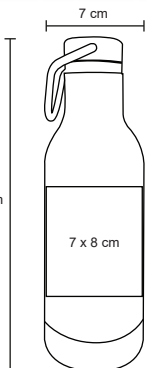

KOFI

T 109

Termo con doble pared de acero inoxidable, tapa con asa metálica enroscable y base de metal. Cap. 500 ml.

- MT Acero Inoxidable
- M 7 x 23.5 cm
- E 50 Pzas
- MI 7 x 8 cm
- TI Tampografía / Láser / Serigrafía





KENUX

T 23

Termo de doble pared de acero inoxidable, tapa que evita derrames, cuenta con candado de seguridad en la boca de la botella. Cap. 500 ml.

- MT Acero Inoxidable
- M 6.5 x 23.5 cm
- E 50 Pzas
- MI 4 x 10 cm
- TI Serigrafía / Láser / Tampografía

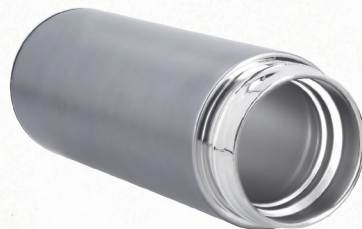
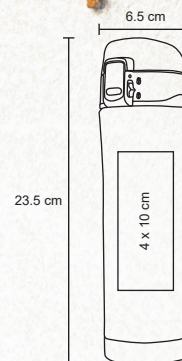

VOUS

T 75

Termo de doble pared de acero inoxidable. Con colador y asa de plástico. Cap. 500 ml.

- MT Acero Inoxidable
- M 7.3 x 21.5 cm
- E 50 Pzas
- MI 5 x 6 cm
- TI Serigrafía / Tampografía / Láser

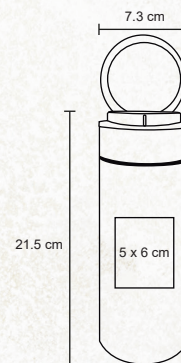

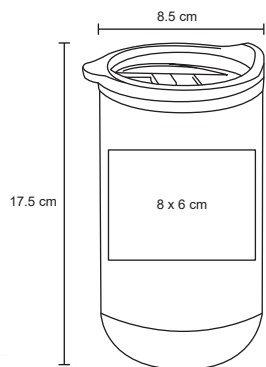

COCOA

NUEVO

T 119

Termo con doble pared de acero inoxidable e interior de plástico, base de corcho y tapa traslúcida a presión, con seguro deslizable y boquilla. Cap. 600 ml.

- MT Acero Inox / Corcho
- M 8.5 x 17.5 cm
- E 25 Pzas
- MI 8 x 6 cm
- TI Tampografía / Láser / Serigrafía





TWIST

T 120

NUEVO

Termo con doble pared de acero inoxidable, tapa enroscable de plástico y boquilla de seguridad. Cap. 500 ml.

- MT Acero Inoxidable
- M 7.7 x 22.5 cm
- E 60 Pzas
- MI 7 x 6 cm
- TI Tampografía / Láser / Serigrafía

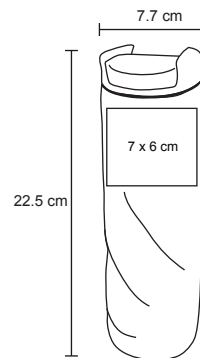

KRAKE

T 39

Termo ergonómico de doble pared de acero inoxidable, tapa enroscable y boquilla con seguro. Cap. 450 ml.

- MT Acero Inoxidable
- M 7 x 20 cm
- E 48 Pzas
- MI 5 x 3 cm
- TI Serigrafía / Láser / Tampografía

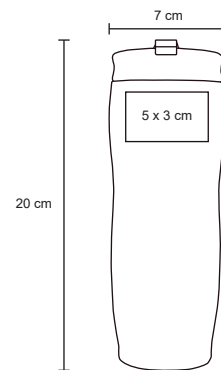

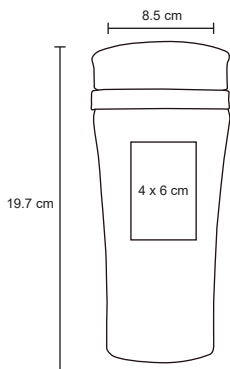

MIKA

T 47

Termo con doble pared de acero inoxidable, tapa hermética enroscable y botón de seguridad para evitar derrames. Cap. 450 ml.



TERBUX

T 27

Termo de doble pared de acero inoxidable, cuenta con boquilla de seguridad. Cap. 500 ml.

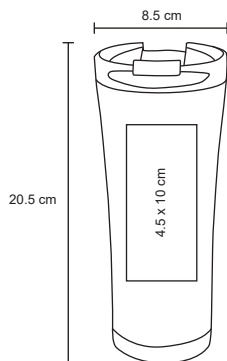

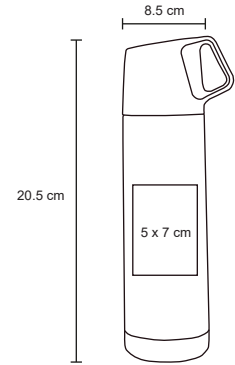

MORIK

T 32

Termo con doble pared de acero inoxidable y tapa que funciona como taza. Cap. 500 ml.

- MT Acero Inox. / Plástico
- M 8.5 x 20.5 cm
- E 50 Pzas
- MI 5 x 7 cm
- TI Serigrafía / Láser / Tampografía



TOWER

TB 500

Termo de acero inoxidable con tapa que se utiliza como vaso. Cap. 500 ml.

- MT Acero Inoxidable
- M 6.6 x 24 cm
- E 24 Pzas
- MI 4 x 15 cm
- TI Serigrafía / Láser / Tampografía

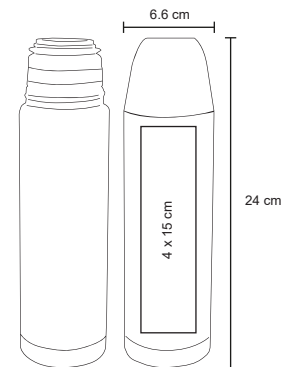

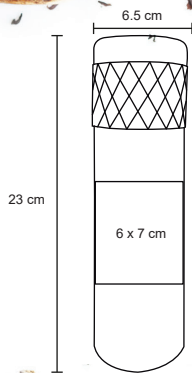

KIA

T 80

Termo de doble pared de acero inoxidable con tapa que se utiliza como vaso. Cap. de 450 ml.

- MT Acero Inoxidable
- M 6.5 x 23 cm
- E 60 Pzas
- MI 6 x 7 cm
- TI Serigrafía / Tampografía / Láser

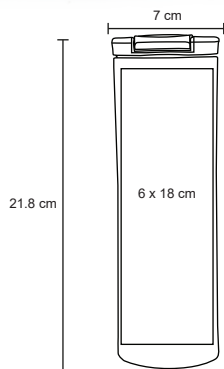

GEM

T 44

Termo con doble pared de acero inoxidable, tapa hermética enroscable y boquilla de seguridad para evitar derrames. Cap. 450 ml.

- MT Acero Inoxidable
- M 7 x 21.8 cm
- E 60 Pzas
- MI 6 x 18 cm
- TI Serigrafía / Láser / Tampografía





FORTE

T 86

Termo de doble pared de acero inoxidable con asa de silicón en la tapa. Cap. 580 ml.

- MT Acero Inoxidable
- M 7.5 x 24 cm
- E 24 Pzas
- MI 4 x 5 cm
- TI Serigrafía / Tampografía / Láser

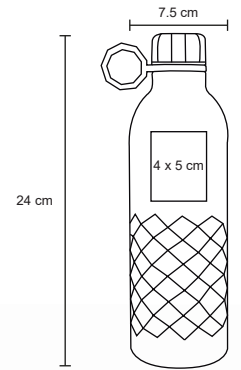

URANO

T 67

Botella térmica con doble pared de acero inoxidable, que mantiene tus bebidas calientes y frías por más tiempo. Con tapa enroscable. Cap. 500 ml.

- MT Acero Inoxidable
- M 7 x 23 cm
- E 50 Pzas
- MI 9 x 11 cm
- TI Serigrafía / Láser / Tampografía

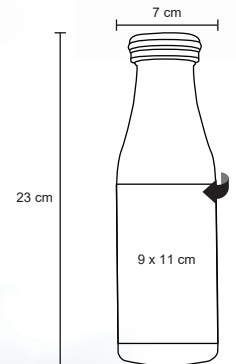

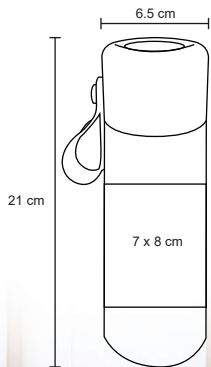

AMARETTO

NUEVO

T 124

Termo difuminado con doble pared de acero inoxidable, colador metálico y tapa de enroscable plástico con correa de silicón. Cap. 360 ml.

MT Acero Inoxidable

M 6.5 x 21 cm

E 60 Pzas

MI 7 x 8 cm

TI Tampografía / Láser / Serigrafía



FROSY

T 58

Termo difuminado con doble pared de acero inoxidable que mantiene tus bebidas calientes y frías por más tiempo. Incluye tapa transparente de cierre a presión. Cap. 500 ml.

MT Acero Inoxidable

M 8.5 x 18.5 cm

E 50 Pzas

MI 13 x 8 cm

TI Serigrafía / Láser / Tampografía

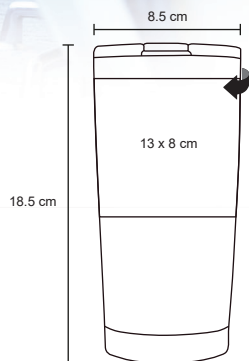



CABANNA

NUEVO

Acabado Rubber

T 88

Termo de alta tecnología, acabado rubber, con doble pared de acero inoxidable, que mantiene tus bebidas calientes y frías por más tiempo. Incluye tapa transparente de cierre a presión. Cap. 870 ml.



Acero Inoxidable / Plástico



10 x 20 cm



20 Pzas



10 x 8 cm



Grabado CO2 / Láser / Serigrafía

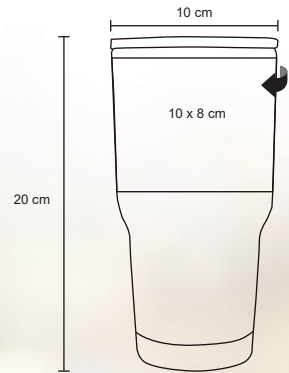

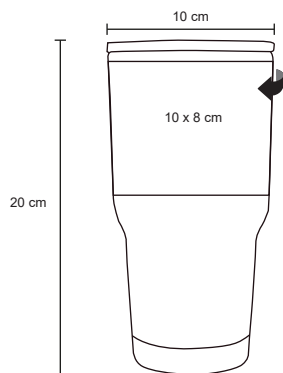

MAK

T 34

**NUEVOS
COLORES**

Termo de alta tecnología con doble pared de acero inoxidable, que mantiene tus bebidas calientes y frías por más tiempo. Incluye tapa transparente de cierre a presión. Cap. 870 ml.

MT Acero Inoxidable / Plástico
 M 10 x 20 cm
 E 20 Pzas
 MI 10 x 8 cm
 TI Serigrafía / Láser / Tampografía





DUVA

T 35

Termo de alta tecnología con doble pared de acero inoxidable que mantiene tus bebidas calientes y frías por más tiempo. Incluye tapa transparente de cierre a presión. Cap. 600 ml.

NUEVOS
COLORES

MT Acero Inoxidable

M 8,5 x 18,5 cm

E 60 Pzas

MI 13 x 8 cm

TI Serigrafía / Láser / Tampografía

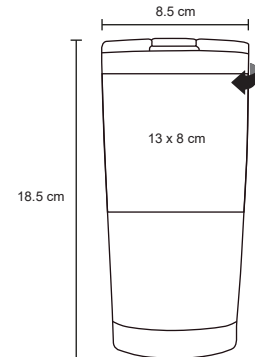

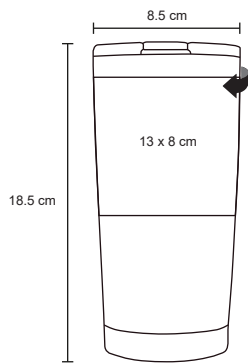

MOSCÚ

NUEVO

Acabado Rubber

T 89

Termo de alta tecnología, acabado rubber con doble pared de acero inoxidable que mantiene tus bebidas calientes y frías por más tiempo. Incluye tapa de presión transparente. Cap. 600 ml.



Acero Inoxidable



8,5 x 18,5 cm



60 Pzas



13 x 8 cm



Láser / Serigrafía

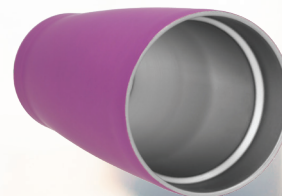



CARSON

T 64

Termo de doble pared de acero inoxidable, con tapa de cierre a presión transparente. Cap. 300 ml.

NUEVOS
COLORES

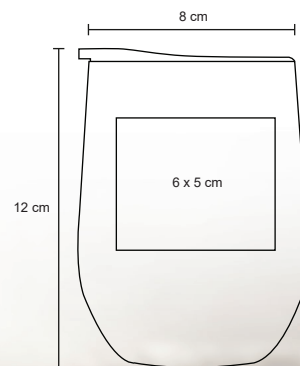

- MT Acero Inoxidable / M 8 x 12 cm E 30 Pzas
- MI 6 x 5 cm TI Serigrafía / Láser / Tampografía



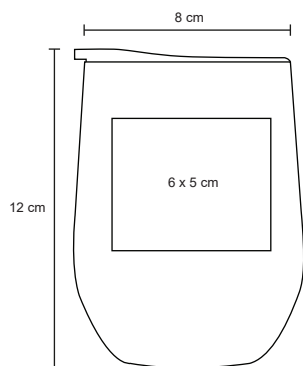

GOLDEN

NUEVO

T 122

Termo con doble pared de acero inoxidable en acabado espejo, con tapa transparente de cierre a presión. Cap. 300 ml.

MT Acero Inoxidable / Plástico

M 8 x 12 cm

E 30 Pzas

MI 6 x 5 cm

TI Tampografía / Láser / Serigrafía

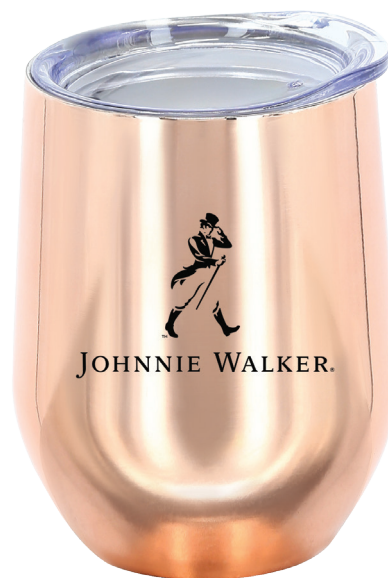

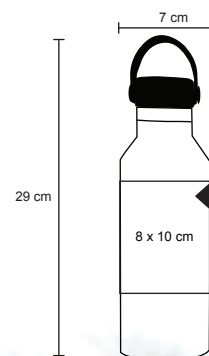

ARMANI

NUEVO

T 130

Termo con doble pared de acero inoxidable con tapa enroscable, asa de plástico y textura en el cuerpo. Cap. 560 ml.

- MT Acero Inoxidable
- M 7 x 29 cm
- E 40 Pzas
- MI 8 x 10 cm
- TI Tampografía / Láser / Serigrafía



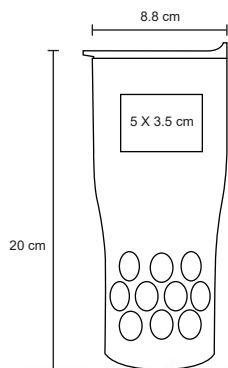

RISTRETTO

T 74

Termo de alta tecnología con doble pared de acero inoxidable. Incluye tapa transparente de cierre a presión. Cap. de 720 ml.



Acero Inoxidable



8.8 x 20 cm



30 Pzas



5 x 3.5 cm



Serigrafía / Tampografía / Láser



KAO

NUEVO

T 102

Termo con doble pared de acero inoxidable con tapa traslúcida y cierre a presión, boquilla de silicón y popote metálico incluido. Cap. 580 ml.

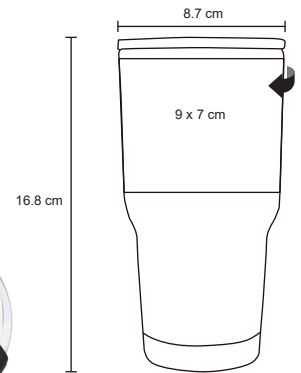

- MT Acero Inoxidable
- M 8.7 x 16.8 cm
- E 48 Pzas
- MI 9 x 7 cm
- TI Tampografía / Láser / Serigrafía



NAMASTÉ

NUEVO

T 105

Termo con doble pared de vidrio con tapa enroscable de plástico, boquilla de seguridad a presión y filtro de plástico con boquilla. Cap. 530 ml.

- MT Vidrio
- M 7.7 x 22 cm
- E 40 Pzas
- MI 9 x 12 cm
- TI Tampografía / Serigrafía

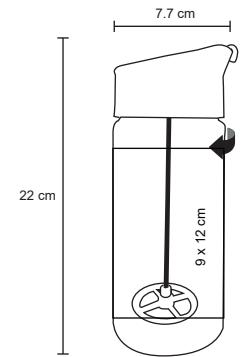

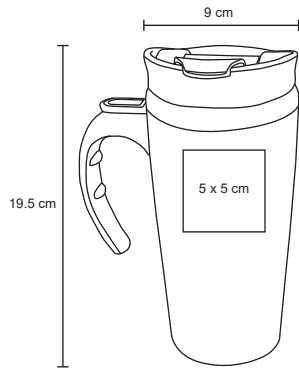

VETTEL

T 24

Termo de doble pared con mango de plástico, interior de acero inoxidable. Incluye en la parte inferior una venosa para fijarlo a una superficie. Cap. 400 ml.



Acero Inoxidable / Plástico



9 x 19.5 cm



48 Pzas



5 x 5 cm



Serigrafía / Láser / Tampografía

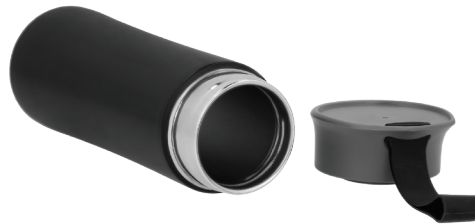

VOLCANO

NUEVO

T 107

Termo con doble pared de acero inoxidable, tapa enroscable de plástico y correa de silicón. Cap. 230 ml.



Acero Inoxidable / Plástico



6.5 x 19 cm



50 Pzas



6 x 10 cm



Tampografía / Láser / Serigrafía

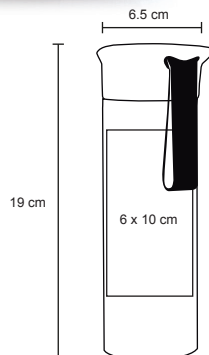



MAYKON

T 62

Termo de doble pared con interior de plástico, con tapa de cierre a presión. Cap. 500 ml.

- MT Acero Inoxidable / Plástico
- M 8.5 x 18 cm
- E 24 Pzas
- MI 8 x 7 cm
- TI Serigrafía / Láser / Tampografía

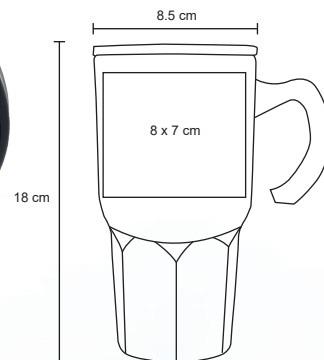

KOBE

T 65

Termo con doble pared de acero inoxidable, con interior de plástico, y tapa transparente de cierre a presión con seguro deslizable. Cap. 450 ml.

- MT Acero Inox / Plástico
- M 8 x 18 cm
- E 24 Pzas
- MI 8 x 8 cm
- TI Serigrafía / Láser / Tampografía

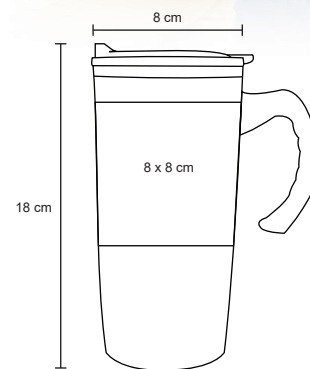



ONIX

NUEVO

T 125

Termo con doble pared de acero inoxidable e interior de plástico, adaptable al portavasos de tu auto, con asa y tapa de plástico a presión con seguro deslizable. Cap. 450 ml.



Acero Inoxidable / Plástico



8,5 x 14,7 cm



50 Pzas



7 x 6 cm



Tampografía / Láser / Serigrafía

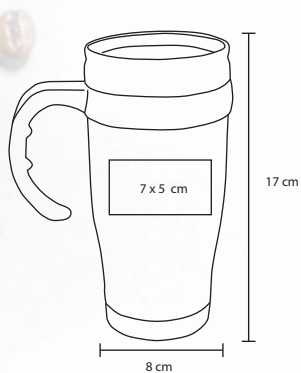

CALI

T 01

Termo de acero inoxidable con interior de plástico, incluye tapa con rosca que evita derrames y boquilla de seguridad. Cap. 500 ml.



Acero Inoxidable / Plástico



8 x 17 cm



48 Pzas



7 x 5 cm



Serigrafía / Láser / Tampografía



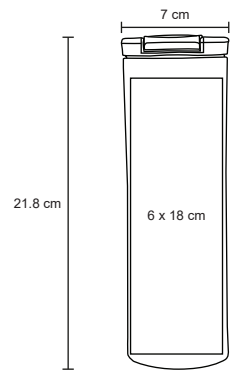

MELT

T 70



Termo de plástico con doble pared, tapa enroscable y válvula de seguridad. Cap. 500 ml.

- MT Plástico
- M 7 x 21.8 cm
- E 50 Pzas
- MI 6 x 18 cm
- TI Serigrafía / Tampografía



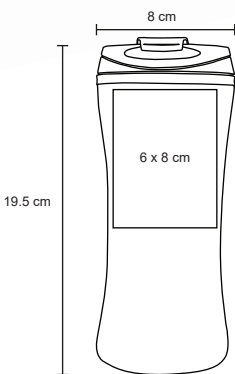

REQ

T 37

Termo ergonómico doble pared, interior de plástico y tapa enroscable. Cap. 450 ml.

- MT Acero Inox. / Plástico
- M 8 x 19.5 cm
- E 48 Pzas
- MI 6 x 8 cm
- TI Serigrafía / Láser / Tampografía

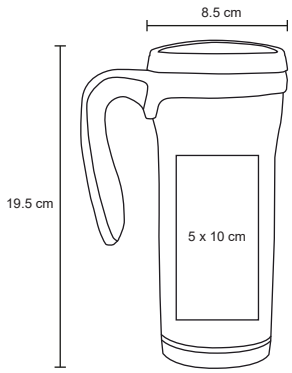

NILO

T 25

Termo de acero inoxidable con mango e interior de plástico y botón deslizable. Cap. 500 ml.

- MT Acero Inox. / Plástico
- M 8.5 x 19.5 cm
- E 48 Pzas
- MI 5 x 10 cm
- TI Serigrafía / Láser / Tampografía



YAREN

T 63

Termo de acero inoxidable con acabado mate y correa para sujetar. Cap. 380 ml.

MT Acero Inoxidable / Plástico
 M 6 x 23 cm
 E 60 Pzas
 MI 6 x 13 cm
 TI Serigrafía / Tampografía / Láser

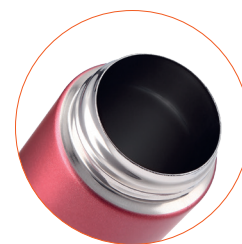
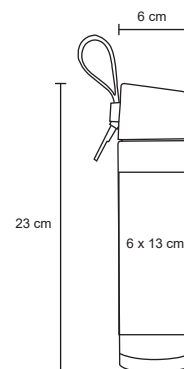

TOG

T 45

Termo de doble pared con interior de plástico, tapa enroscable y boquilla de seguridad. Cap. 450 ml.

MT Acero Inox. / Plástico
 M 7 x 218 cm
 E 60 Pzas
 MI 5 x 6 cm
 TI Serigrafía / Láser / Tampografía

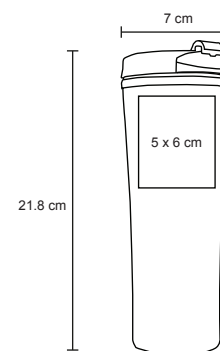

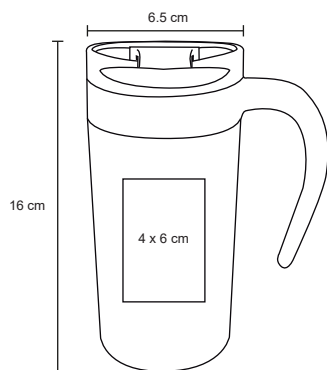

COFIX

NUEVO



T 84

Termo de plástico con tapa enroscable que evita derrames y boquilla de seguridad. Cap. 350 ml.

- MT Plástico
- M 6.5 x 16 cm
- E 50 Pzas
- MI 4 x 6 cm
- TI Serigrafía / Tampografía





MACCHIATO

NUEVO

T 115

Termo con doble pared de acero inoxidable, con tapa plástica enroscable y boquilla de seguridad. Cap. 550 ml.

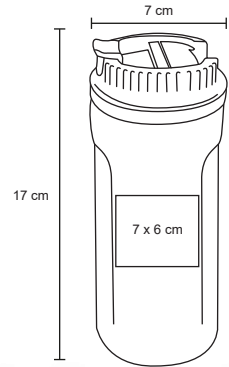

- MT Acero Inoxidable
- M 7 x 17 cm
- E 50 Pzas
- MI 7 x 6 cm
- TI Tampografía / Láser / Serigrafía



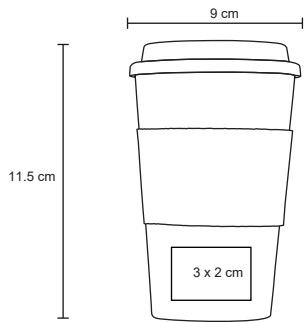

BIO

NUEVO

T 129

Vaso de fibra de bambú con tapa enroscable de plástico y manga. Cap. 350 ml.

MT Fibra de bambú

M 9 x 11,5 cm

E 40 Pzas

MI 3 x 2 cm

TI Tampografía / Serigrafía



MUG

T 21

Termo de plástico con cintillo de color. Cap. 500 ml.



MT Plástico

M 9 x 17,8 cm

E 32 Pzas.

MI 5 x 1,7 cm

TI Serigrafía / Tampografía





THAI

NUEVO

T 94

Cilindro de acero inoxidable, con tapa enroscable y correa de poliéster. Cap. 750 ml.

- MT Acero Inoxidable
- M 6.6 x 27 cm
- E 60 Pzas
- MI 7 x 10 cm
- TI Tampografía / Láser / Serigrafía



QUARTZ

NUEVO

T 97

Cilindro de acero inoxidable con tapa enroscable y correa de poliéster. Cap. 800 ml.

- MT Acero Inoxidable
- M 7 x 25 cm
- E 60 Pzas
- MI 5 x 3 cm
- TI Tampografía / Láser / Serigrafía



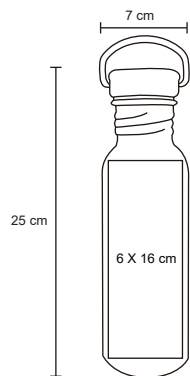

HANNAH

T 53

Botella de acero inoxidable con detalle de bambú en tapa. Cap. 750 ml.



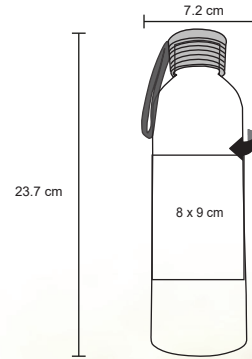

TÚCAN

NUEVO

T 95

Cilindro de acero inoxidable, con tapa de plástico traslúcida enroscable y correa de silicón. Cap. 800 ml.

- MT Acero Inoxidable
- M 7.2 x 23.7 cm
- E 60 Pzas
- MI 8 x 9 cm
- TI Tampografía / Láser / Serigrafía



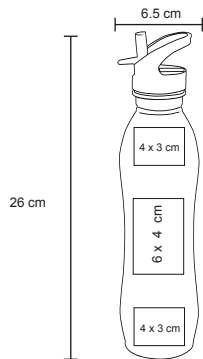

ZURICH

T 07

Cilindro de acero inoxidable con boquilla y popote Cap . 750 ml.

MT Acero inoxidable
 M 6.5 x 26 cm
 E 60 Pzas.
 MI 4 x 3 cm
 TI Láser / Tampografía Serigrafía



CITLALI

T 52

Cilindro de acero inoxidable con cintillo de silicón Cap. 600 ml.

MT Acero Inoxidable / Plástico
 M 6.5 x 25 cm
 E 60 Pzas
 MI 5 x 7 cm
 TI Serigrafía / Láser / Tampografía

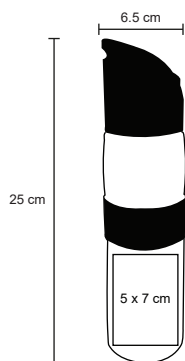



BELINI

T 79

Cilindro metálico de acero inoxidable con asa de plástico. Cap. de 800 ml.

- MT Acero Inoxidable / Plástico
- M 7,5 x 25 cm
- E 60 Pzas
- MI 5 x 3,5 cm
- TI Serigrafía / Tampografía / Láser

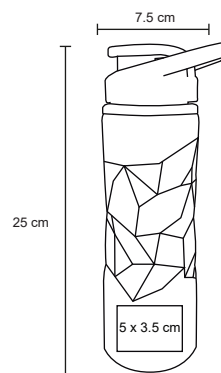

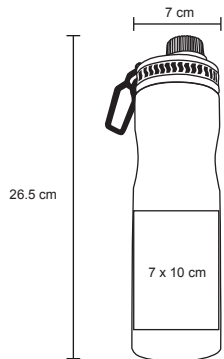

ACQUA

NUEVO

T 96

Cilindro de acero inoxidable con sujetador, tapa con cintillo de silicón y boquilla enroscable de plástico. Cap. 750 ml.



Acero inoxidable / Plástico



7 x 26.5 cm



60 Pzas



7 x 10 cm



Tampografía / Láser / Serigrafía

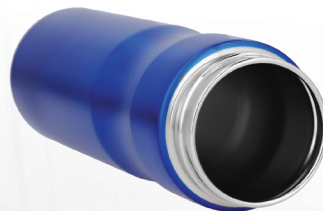

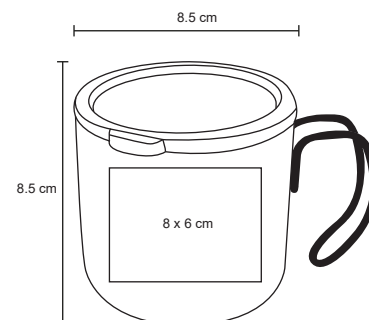

CHAI

NUEVO

T 101

Taza con doble pared de acero inoxidable con asa metálica y tapa traslúcida de cierre a presión, con seguro deslizable y boquilla. Cap. 375 ml.

MT Acero Inoxidable

M 8.5 x 8.5 cm

E 60 Pzas

MI 8 x 6 cm

TI Tampografía / Láser / Serigrafía





KORALE

T 31

Taza térmica con doble pared de acero inoxidable y asa de plástico. Cap. 250 ml.

MT Acero Inoxidable M 7 x 13 cm E 48 Pzas MI 6 x 9 cm TI Serigrafía / Láser / Tampografía

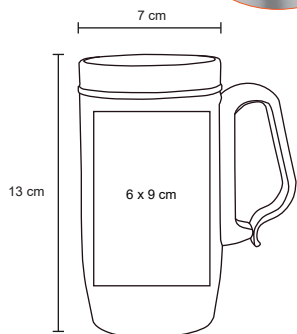

YUKON

T 56

Taza térmica con doble pared de acero inoxidable y asa de plástico. Cap. 250 ml.

MT Acero inoxidable M 8 x 10,5 cm E 50 Pzas MI 5 x 4 cm TI Láser / Tampografía





EVIN

T 46

Taza térmica con doble pared de acero inoxidable, tapa de cierre a presión, asa de plástico y válvula de seguridad. Cap. 450 ml.

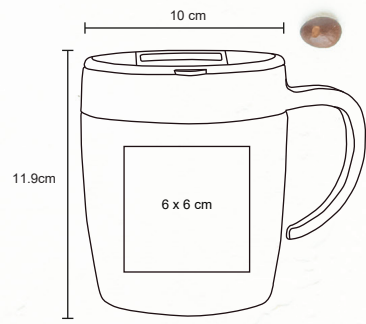

- MT Acero Inoxidable
- M 10 x 11.9 cm
- E 48 Pzas
- MI 6 x 6 cm
- TI Serigrafía / Láser / Tampografía

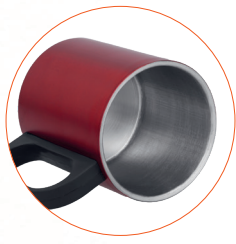

MOKA

T 72

Taza de acero inoxidable acabado mate y asa de plástico. Cap. de 180 ml.

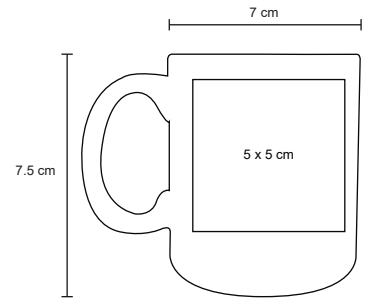

- MT Acero Inoxidable
- M 7 x 7.5 cm
- E 100 Pzas
- MI 5 x 5 cm
- TI Serigrafía / Láser / Tampografía / Grabado CO2

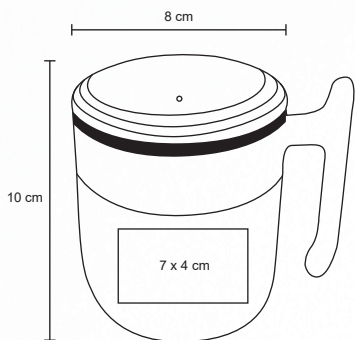

CARTAGENA

NUEVO

T 100

Taza con doble pared de acero inoxidable, tapa de cierre a presión y asa de plástico. Cap. 360 ml.



Acero Inoxidable /
Plástico



8 x 10 cm



60 Pzas



7 x 4 cm



Tampografía / Serigrafía



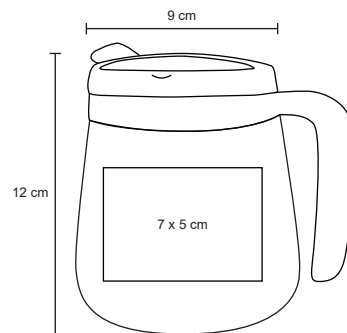

BILBAO

NUEVO

T 99

Taza con doble pared de acero inoxidable con base de silicón, asa de plástico y tapa de cierre a presión con válvula de seguridad. Cap. 365 ml.



MT Acero Inoxidable / Plástico
 M 9 x 12 cm
 E 50 Pzas
 MI 7 x 5 cm
 TI Tampografía / Láser / Serigrafía



LUWAK

HO 029

Taza de vidrio de doble pared. Cap. 175 ml.

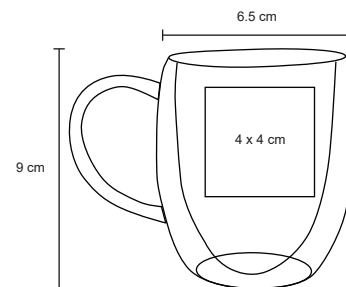

MT Vidrio
 M 6.5 x 9 cm
 E 60 Pzas
 MI 4 x 4 cm
 TI Serigrafía

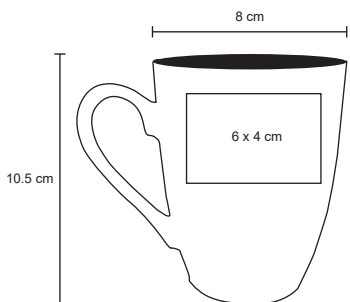

KOZ

HO 021

Taza de cerámica con acabado Rubber. Cap. 400 ml.

MT Cerámica

M 8 x 10.5 cm

E 36 Pzas

MI 6 x 4 cm

TI Grabado CO2



**CERÁMICA
TERMINADO RUBBER**



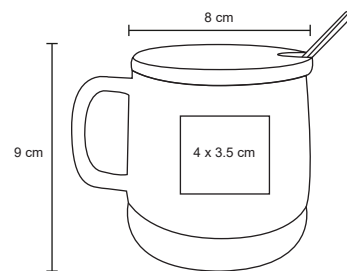

CÁLIZ

HO 026

Taza de cerámica acabado mate con tapa de bambú. Incluye cuchara de acero inoxidable. Cap. de 450 ml.

MT Cerámica

M 8 x 9 cm

E 48 Pzas

MI 4 x 3.5 cm

TI Serigrafía / Tampografía



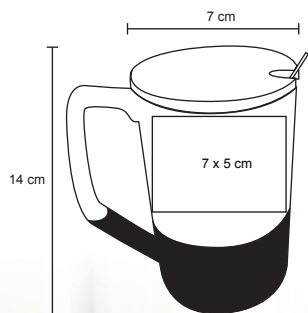

ALICANTE

NUEVO

HO 047

Taza de cerámica con acabado mate y texturizado en la parte inferior, tapa de bambú y cuchara de acero inoxidable. Cap. 485 ml.

MT Cerámica

M 7 x 14 cm

E 60 Pzas

MI 7 x 5 cm

TI Tampografía / Serigrafía / Sandblast

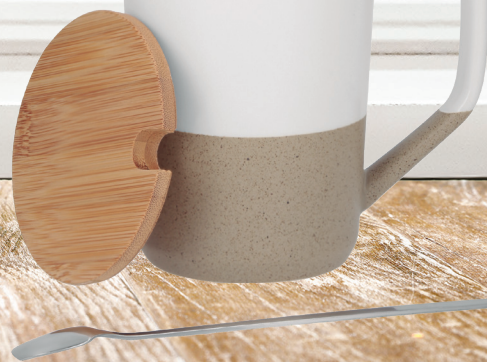



CARRARA

HO 048

Taza de cerámica con apariencia de mármol. Cap. 365 ml.

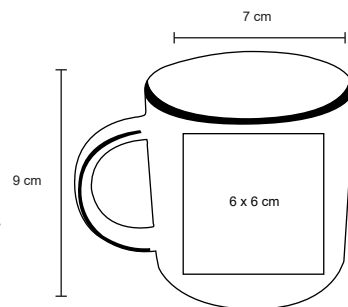

MT Cerámica

M 7 x 9 cm

E 72 Pzas

MI 6 x 6 cm

TI Tampografía / Serigrafía



VERANDA

HO 049

Taza de cerámica con acabado texturizado y placa de metal. Cap. 375 ml.

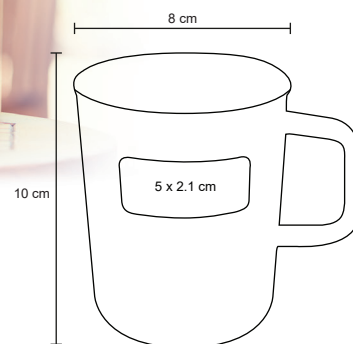

MT Cerámica / Metal

M 8 x 10 cm

E 60 Pzas

MI 5 x 2.1 cm

TI Tampografía / Láser Serigrafía

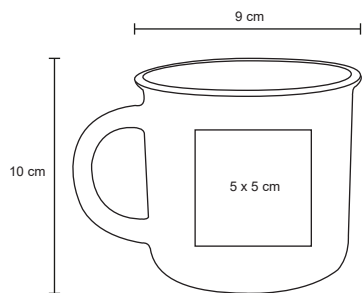

WOMB

HO 032

Taza de cerámica estilo vintage. Exterior con detalles que simulan desgaste.
Cap. de 320 ml.

MT Cerámica
M 9 x 10 cm
E 36 Pzas
MI 5 x 5 cm
TI Serigrafía / Tampografía





FLORIAN

HO 028

Taza de cerámica con apariencia metálica. Cap. 350 ml.

- MT Cerámica
- M 9 x 11 cm
- E 48 Pzas
- MI 5 x 4 cm
- TI Serigrafía / Tampografía / Láser

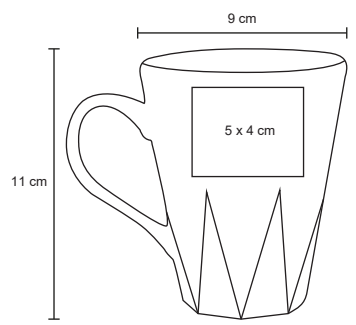

DUKA

HO 020

Vaso de cerámica con manga de silicon. Cap. 400 ml.

- MT Cerámica / Silicon / Plástico
- M 9 x 14,5 cm
- E 60 Pzas
- MI 9 x 3 cm
- TI Serigrafía / Tampografía

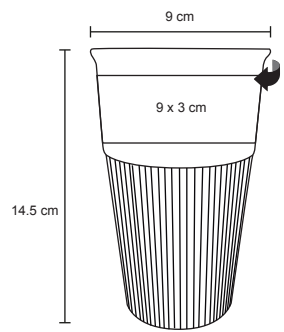



GOZI

HO 022

Taza de cerámica con cintillo de silicón en la base. Cap. 400 ml.

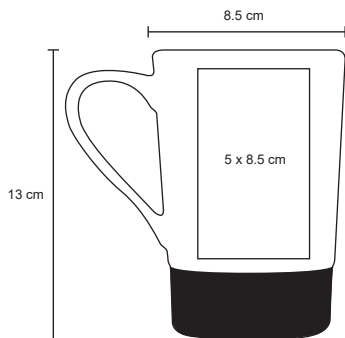

- MT Cerámica
- M 8.5 x 13 cm
- E 72 Pzas
- MI 5 x 8.5 cm
- TI Serigrafía / Tampografía

CERÁMICA

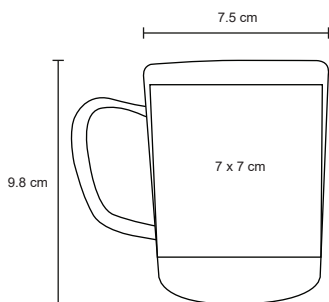

SAHARA

NUEVO

T 98

Taza de wheat straw (fibra de trigo), resistente a líquidos calientes. Cap. 345 ml.

- MT Wheat Straw
- M 7.5 x 9.8 cm
- E 120 Pzas
- MI 7 x 7 cm
- TI Tampografía / Serigrafía



LATTE

T 73

Vaso de acero inoxidable con doble pared. Incluye popote metálico. Cap. de 500 ml.

- MT Acero Inoxidable
- M 9 x 17 cm
- E 50 Pzas
- MI 6 x 5 cm
- TI Serigrafía / Láser / Tampografía

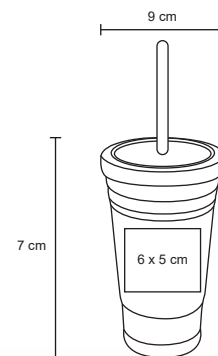

LAGER

T 83

Porta latas con doble pared de acero inoxidable y tapa enroscable de plástico transparente con aditamento para convertirse en termo. Cap. de 360 ml.

- MT Acero Inoxidable / Plástico
- M 8 x 12,5 cm
- E 25 Pzas
- MI 5 x 3 cm
- TI Serigrafía / Tampografía / Láser

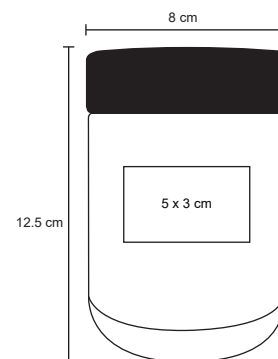

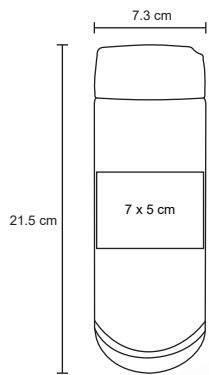

FERNET

T 78

Termo de doble pared de acero inoxidable y tapa enroscable transparente, con aditamento para convertirse en porta lata o porta botella. Capacidad de 650 ml.

- MT Acero Inox
- M 7.3 x 21.5 cm
- E 30 Pzas
- MI 7 x 5 cm
- TI Serigrafía / Tampografía / Láser

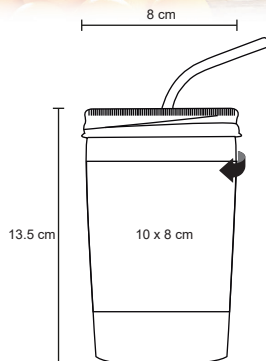

MINSK

T 60

Vaso de cerámica con tapa y popote metálico. Cap. 400 ml.

- MT Cerámica
- M 8 x 13.5 cm
- E 60 Pzas
- MI 10 x 8 cm
- TI Serigrafía / Tampografía





PROTEIN

NUEVO

T 93

Shaker de acero inoxidable con medidor, bola mezcladora de acero y tapa enroscable con boquilla. Cap. 750 ml.

- MT Acero Inoxidable
- M 7 x 22 cm
- E 50 Pzas
- MI 6 x 6 cm
- TI Tampografía / Láser / Serigrafía

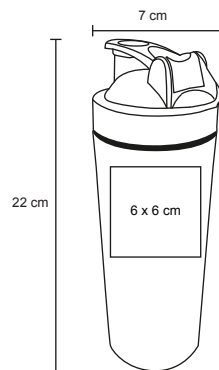

MIX

NUEVO

T 91

Shaker de plástico con compartimento, bola mezcladora plástica y tapa. Cap. 500 ml. 26 cm

- MT Plástico
- M 7.5 x 26 cm
- E 48 Pzas
- MI 5 x 8 cm
- TI Tampografía / Serigrafía

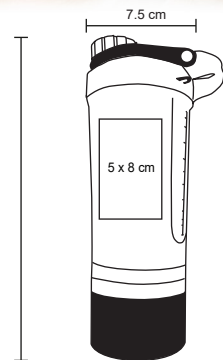

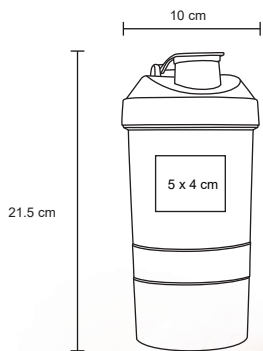

GYM

T 18

Cilindro de plástico con compartimientos, resorte de acero y colador. Ideal para gimnasio. Cap. 450 ml.

- MIT Plástico
- M 10 x 215 cm
- E 72 Pzas.
- MI 5 x 4 cm
- TI Serigrafía / Tampografía



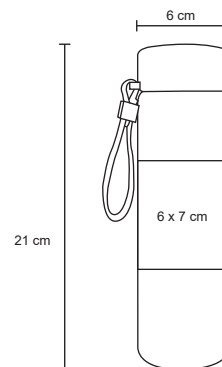

SANTORINI

NUEVOS
COLORES

T 82

Botella de vidrio con tapa tipo rosca y correa de silicón. Cap. de 320 ml.

MT Vidrio

M 6 x 21 cm

E 60 Pzas

MI 6 x 7 cm

TI Serigrafía / Tampografía



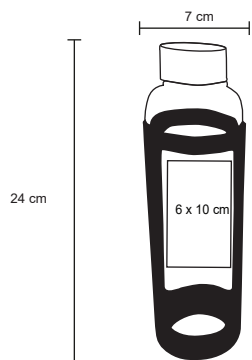

CRYSTAL

NUEVO

T 126

Cilindro de vidrio con tapa metálica enroscable y funda de silicón. Cap. 570 ml.

MT Vidrio / Silicón / Metal
 M 7 x 24 cm
 E 50 Pzas
 MI 6 x 10 cm
 TI Tampografía / Láser / Serigrafía

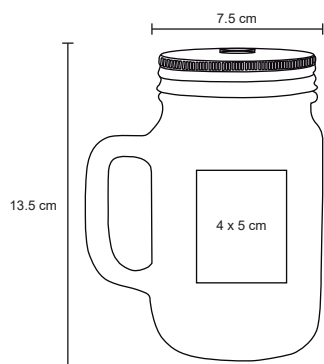

ABELO

T 40

Tarro de vidrio con asa. Tapa metálica. Incluye popote rígido. Cap. 450 ml.

MT Vidrio
 M 7.5 x 13.5 cm
 E 48 Pzas
 MI 4 x 5 cm
 TI Serigrafía / Tampografía / Sand Blast



COSMOS

T 26

Vaso tipo frozen de doble pared con asa de plástico. Incluye un compartimento en la tapa para guardar algún suplemento o polvo. Cap. 400 ml.

MT Plástico M 7.5 x 18.3 cm E 100 Pzas.

MI 5 x 4 cm TI Serigrafía / Tampografía

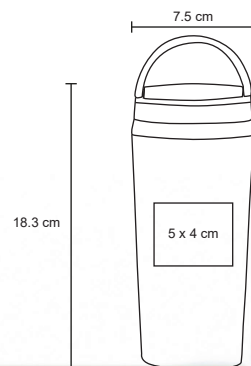

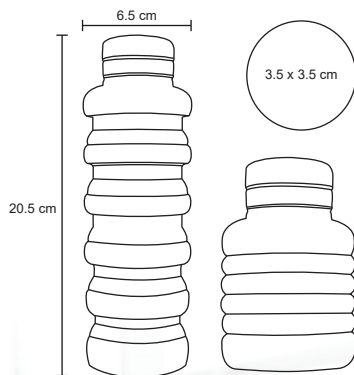

FLEX

T 92

Cilindro de silicón tipo acordeón que se extiende y se contrae, con tapa metálica enroscable y arnés. Cap. 500 ml.

NUEVO

- MT Silicón
- M 6.5 x 20.5 cm
- E 100 Pzas
- MI 3.5 Diámetro
- TI Tampografía / Láser





RUBIN

T 36

Botella plástica en forma de garrafa, Acabado frozen. Tapa de rosca. Cap. 380 ml.

- MT Plástico
- MI 12.7 x 21.5 cm
- E 80 Pzas
- MI 8.5 x 12 cm
- TI Serigrafía / Tampografía

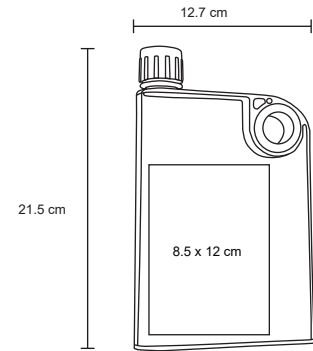

DRYSOR

T 38

Cilindro de plástico transparente con tapa de rosca, popote con protector y seguro. Incluye correa de mano. Cap. 720 ml.

MT Plástico
 M 7.1 x 23 cm
 E 48 Pzas
 MI 10 x 13 cm
 TI Serigrafía / Tampografía

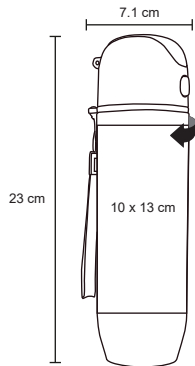

ANTARA

T 11

Cilindro de plástico con seguro en la tapa, manga y cordón de poliéster. Cap. 600 ml.

MT Plástico
 M 7.5 x 22.5 cm
 E 80 Pzas
 MI 5 x 7 cm
 TI Serigrafía / Tampografía

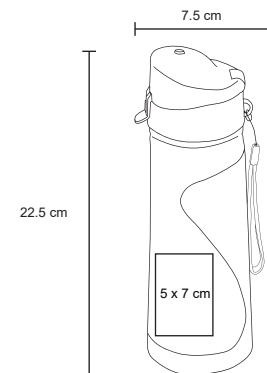



CUP

NUEVO

T 127

Vaso de acero inoxidable. Cap. 480 ml.

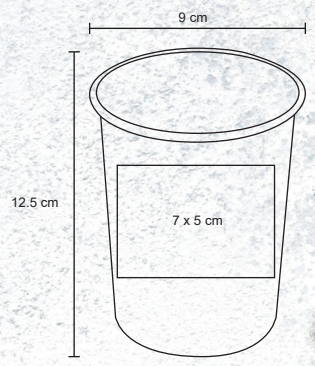

- MT** Acero inoxidable
- M** 9 x 12.5 cm
- E** 500 Pzas
- MI** 7 x 5 cm
- TI** Tampografía / Láser / Serigrafía



PILSEN

NUEVO

T 128

Tarro con doble pared de acero inoxidable. Cap. 300 ml.

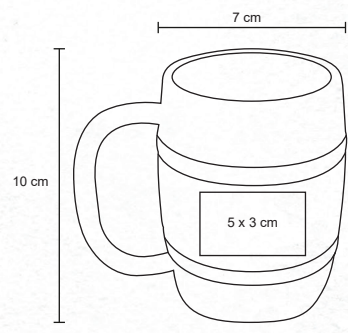

- MT** Acero inoxidable
- M** 7 x 10 cm
- E** 60 Pzas
- MI** 5 x 3 cm
- TI** Tampografía / Láser

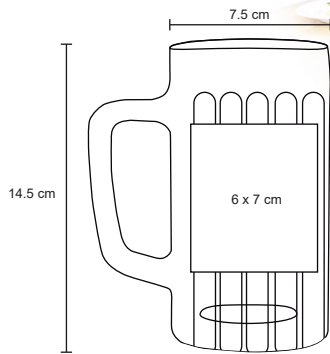

BEER

T 41

Tarro cervecero de vidrio con asa. Cap. 360 ml.

MT Vidrio M 7.5 x 14.5 cm E 36 Pzas

MI 6 x 7 cm TI Serigrafía / Tampografía / Sand Blast

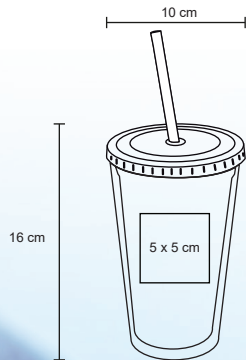

HABANA

T 66

Vaso de doble pared de plástico con popote Cap. 500 ml.



MT Plástico M 10 x 16 cm E 48 Pzas MI 5 x 5 cm TI Serigrafía





TROPICAL

T 48T



Vaso de doble pared de plástico con popote Cap. 500 ml.

- MT Plástico
- M 10 x 16 cm
- E 48 Pzas.
- MI 5 x 5 cm
- TI Serigrafía / Tampografía

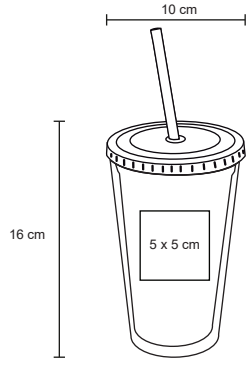

ROCK

T 87



Vaso de plástico con tapa y popote. Cap. 500 ml

- MT Plástico
- M 9.3 x 14.2 cm
- E 150 Pzas.
- MI 8 x 6 cm
- TI Serigrafía

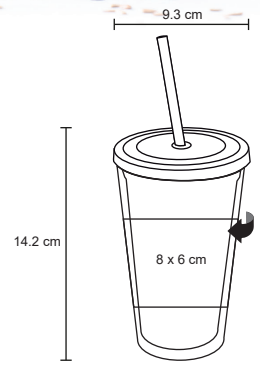

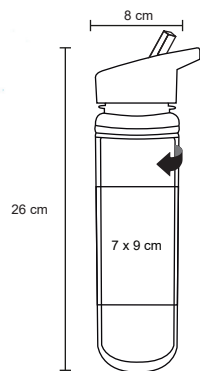

IBIZA

T 68



Cilindro de plástico de doble pared, popote y boquilla. Cap. 600 ml.

- MT Plástico
- M 8 x 26 cm
- E 50 Pzas
- MI 7 x 9 cm
- TI Serigrafía / Tampografía





JADE

NUEVO



T 90

Cilindro de plástico con asa sujetadora
Cap. 900 ml.

- MT Plástico
- M 7.5 x 26 cm
- E 40 Pzas
- MI 8 x 14 cm
- TI Tampografía / Serigrafía

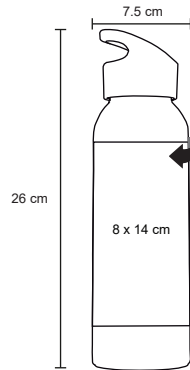



LAYS

T 50

Cilindro de plástico de color traslucido, con asa sujetadora Cap. 900 ml.



- MT Plástico
- M 7.5 x 26 cm
- E 40 Pzas
- MI 8 x 14 cm
- TI Serigrafía / Tampografía

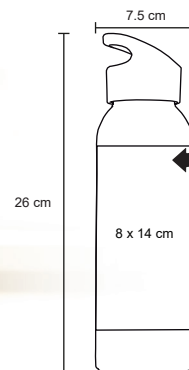



CHICAGO / CALIFORNIA

T 17

Cilindro de plástico con tapa enroscable. Cap. 655 ml



MT Plástico
 M 6.5 x 24.5 cm
 E 50 Pzas.
 MI 4 x 7 cm
 TI Tampografía

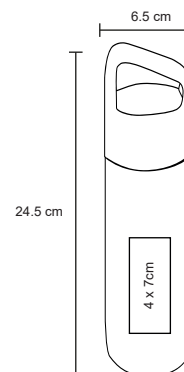

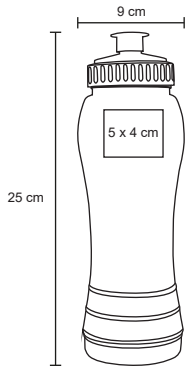

POP

T 19



Cilindro de plástico de color traslúcido con chupón Cap. 700 ml

MT Plástico
 M 9 x 25 cm
 E 50 Pzas.
 MI 5 x 4 cm
 TI Tampografía

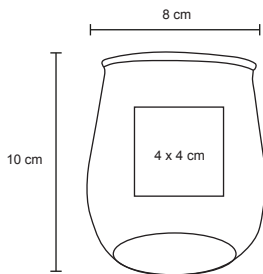

BALI

T 133

NUEVO

Vaso de plástico de color traslúcido. Cap 350 ml.

MT Plástico
 M 8 x 10 cm
 E 120 Pzas.
 MI 4 x 4 cm
 TI Serigrafía / Tampografía





SPARK

NUEVO



T 131

Cilindro de plástico de color traslucido con tapa enroscable. Cap. 660 ml.

- MT Plástico
- M 6.5 x 22 cm
- E 120 Pzas
- MI 9 x 14 cm
- TI Serigrafía / Tampografía

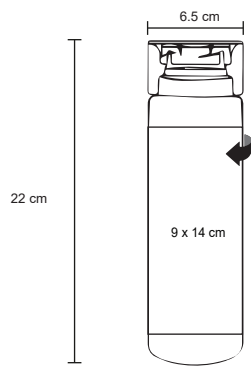

TESLA

NUEVO



T 132

Cilindro de plástico con tapa enroscable. Cap. 660 ml.

- MT Plástico
- M 6.5 x 22 cm
- E 120 Pzas
- MI 9 x 14 cm
- TI Serigrafía / Tampografía

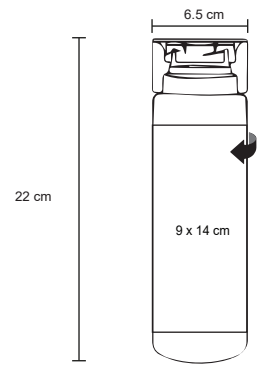

FENIX

NUEVO



T 135

Cilindro de plástico con tapa enroscable de color. Cap. 1 L.

MT Plástico

M 7.5 x 30 cm

E 70 Pzas

MI 7 x 20 cm

TI Serigrafía / Tampografía

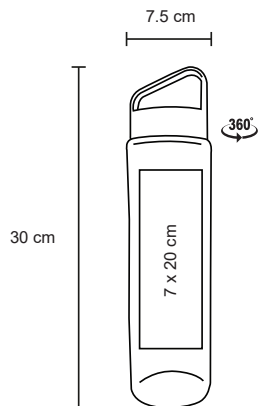

DEXTER

NUEVO



T 134

Cilindro de plástico de color traslucido con tapa enroscable. Cap. 1 L.

MT Plástico

M 7.5 x 30 cm

E 90 Pzas

MI 7 x 20 cm

TI Serigrafía / Tampografía

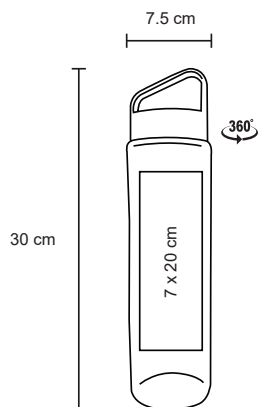

DINAMO

T 48

Cilindro de plástico con popote y asa
sujetadora Cap. 800 ml.



MT Plástico

M 7.5 x 23.5 cm

E 38 Pzas

MI 5.5 x 5.5 cm

TI Serigrafía / Tampografía

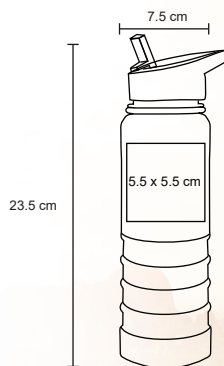



ENZO

T 29

**NUEVOS
COLORES**



Cilindro de plástico con chupón de silicón y tapa que sirve como vaso. Cap. 700 ml.

MT Plástico

M 7.2 x 29.7 cm

E 50 Pzas

MI 7 x 12 cm

TI Serigrafía / Tampografía





IRON

T 30



Cilindro squeeze con chupón. Ideal para carreras y competencias. Cap. 600 ml.

- MT Plástico
- M 7.3 x 20.5 cm
- E 40 Pzas
- MI 6 x 7 cm
- TI Serigrafía / Tampografía

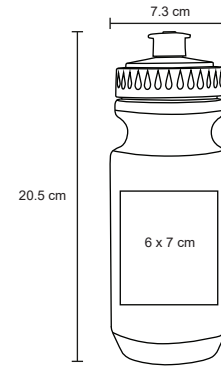

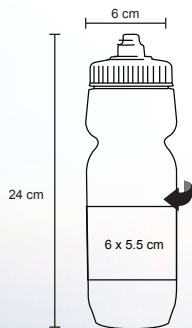

BITROK

T 71

Cilindro squeeze de color sólido con chupón ideal para carreras y competencias. Cap. 720 ml.



- MT Plástico
- M 6 x 24 cm
- E 50 Pzas
- MI 6 x 5.5 cm
- TI Serigrafía / Tampografía



BOLÍGRAFOS METÁLICOS



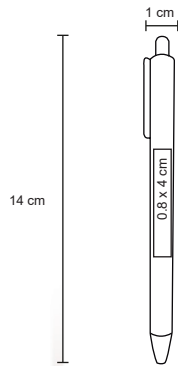

MEDAL

AL 19880

NUEVO

Bolígrafo metálico con acabado en espejo, clip y mecanismo de click.



Metal



1 x 14 cm



500 Pzas.



0.8 x 4 cm



Tampografía / Láser / Serigrafía

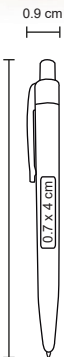

PARIS

AL 18109U

Bolígrafo metálico con clip.



Metal



0.9 x 14 cm



1000 Pzas.



0.7 x 4 cm



Láser / Tampografía



Repuesto disponible en tinta azul





MICHIGAN

FM 0573

Bolígrafo metálico en acabado mate, clip, goma touch screen, detalles en color negro y mecanismo retráctil.

- MT Metal
- M 11 x 13.5 cm
- E 150 Pzas.
- MI 0.8 x 3.5 cm
- TI Tampografía / Láser / Serigrafía

NUEVO

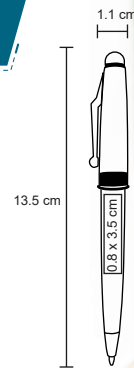

Acabado Rubber

AVENTUS

AL 18115R

Bolígrafo metálico acabado rubber con detalles en base y tapa color gris.

- MT Metal / Rubber
- M 1 x 13.3 cm
- E 1,000 Pzas.
- MI 0.7 x 4 cm
- TI Láser / Tampografía

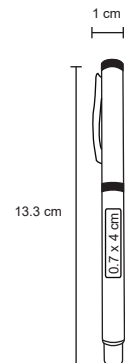

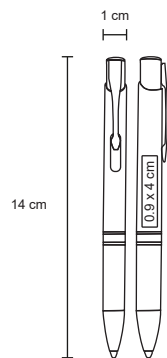

MABIRA

AL 9028M

Bolígrafo metálico con acabado rubber.

MT Metal / Rubber
 M 1 x 14 cm
 E 500 Pzas.
 MI 0.9 x 4 cm
 TI Láser / Serigrafía / Tampografía

Repuesto disponible en tinta azul

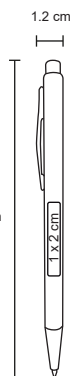

TAGU

AL 17020

Bolígrafo metálico con acabado rubber.

MT Metal / Rubber
 M 12 x 14 cm
 E 500 Pzas.

MI 1 x 2 cm
 TI Láser / Serigrafía / Tampografía

Repuesto disponible en tinta azul





TOBIN

AL 18011

Bolígrafo metálico con acabado rubber.

- MT Metal / Rubber
- M 15 x 14 cm
- E 500 Pzas.
- MI 1 x 45 cm
- TI Láser / Serigrafía / Tampografía

Acabado
Rubber

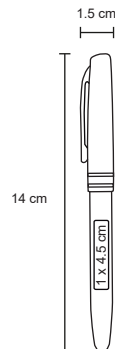

ISKAM

AL 18009

Bolígrafo metálico con acabado rubber y goma touch screen. Mecanismo retráctil.

- MT Metal / Rubber
- M 12 x 14,5 cm
- E 500 Pzas.
- MI 1 x 4 cm
- TI Láser / Serigrafía / Tampografía

Acabado
Rubber

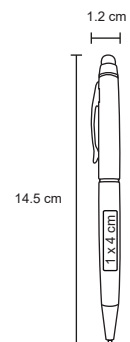

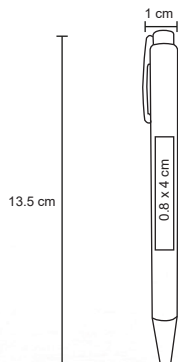

SEVILLA

AL 19130

Bolígrafo de aluminio con detalles en el clip y grip, con mecanismo de click.

- MT Aluminio
- M 1 x 13,5 cm
- E 500 Pzas.
- MI 0,8 x 4 cm
- TI Láser / Tampografía / Serigrafía

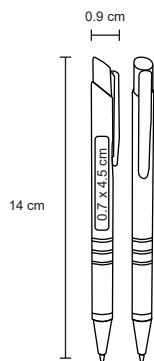

SKY

AL 9029

Bolígrafo de aluminio con clip metálico.

- MT Aluminio
 - M 0,9 x 14 cm
 - E 500 Pzas
 - MI 0,7 x 4,5 cm
 - TI Serigrafía / Tampografía
Láser / Punta diamante
- 💧 Repuesto disponible en tinta azul





VERBEL

AL 5558R

Bolígrafo metálico con acabado rubber y goma óptica touch screen.

Acabado
Rubber

- MT Metal / Rubber
- M 0.8 x 14 cm
- E 500 Pzas.
- MI 0.7 x 45 cm
- TI Láser / Serigrafía / Tampografía

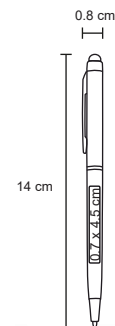

Al grabar en láser, el bolígrafo destaca en espejo y del color de la goma



TIVOX

AL 17020MRT

Bolígrafo metálico con acabado rubber y goma touch screen.

Acabado
Rubber

- MT Metal / Rubber
- M 1 x 14.8 cm
- E 500 Pzas.
- MI 0.7 x 4 cm
- TI Láser / Serigrafía / Tampografía

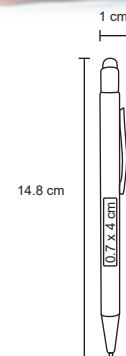

Repuesto disponible en tinta azul



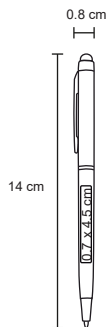

SINATRA

AL 5558D

Bolígrafo de aluminio con goma touch screen. Mecanismo retráctil.

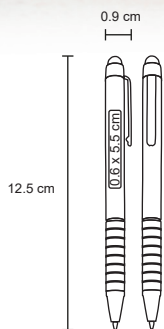
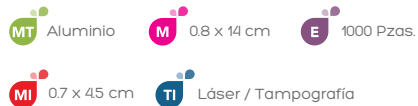

WEKEND

AL 5555

Bolígrafo de aluminio con mecanismo retráctil y goma óptica touch screen.





Al grabar en láser, el bolígrafo destapa en espejo y del color de la goma



LENARD

AL 5555AC

Bolígrafo metálico con mecanismo de click y goma touch screen. Al grabar en láser destapa en espejo del color de la goma.

- MT Aluminio
- M 0.9 x 12.2 cm
- E 500 Pzas.
- MI 0.7 x 3.5 cm
- TI Láser / Tampografía

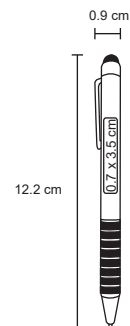

Al grabar en láser, el bolígrafo destapa en espejo y del color de la goma



LEXUS

AL 17020BC

Bolígrafo metálico con mecanismo de click y goma touch screen. Al grabar destapa del color de la goma.

- MT Metal
- M 1 x 14.2 cm
- E 500 Pzas.
- MI 0.7 x 3.5 cm
- TI Láser / Tampografía

Repuesto disponible en tinta azul

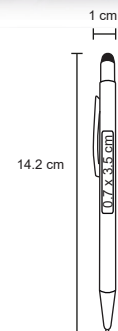

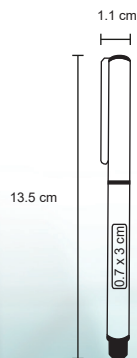

DAVOS

AL 17001

Bolígrafo de aluminio cepillado.



1.3 cm

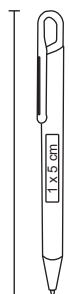

STUART

AL 18010

Bolígrafo metálico con acabado rubber y clip en forma de gancho.

Acabado
Rubber





MELU

FM 8591

Bolígrafo metálico con goma óptica touch screen. Incluye estuche.

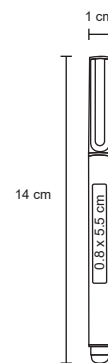

- MT Metal
- M 1 x 14 cm
- E 150 Pzas.
- MI 0.5 x 5.5 cm
- TI Serigrafía / Láser
Tampografía



BARÚ

BP 4143

Bolígrafo de aluminio y clip metálico.

- MT Aluminio
- M 0.8 x 13.8 cm
- E 1000 Pzas
- MI 0.6 x 4.4 cm
- TI Serigrafía / Tampografía
Láser / Punta diamante



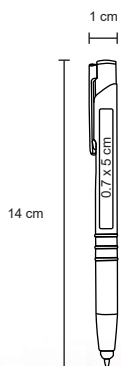

ELEGANCE

AL 9029 TOUCH

Bolígrafo metálico con goma touch screen.

- MT Metal
- M 1 x 14 cm
- E 500 Pzas.
- MI 0.7 x 5 cm
- TI Serigrafía / Láser / Tampografía

Repuesto disponible en tinta azul

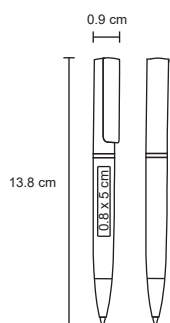

ASTRO

AL 8599

Bolígrafo de aluminio y mecanismo retráctil.

- MT Aluminio
- M 0.9 x 13.8 cm
- E 500 Pzas.
- MI 0.8 x 5 cm
- TI Serigrafía / Láser / Tampografía

Repuesto disponible en tinta azul





• Tinta gel

NIK

AL 8265

Bolígrafo de aluminio con tinta gel.

MT Aluminio M 11 x 14 cm E 500 Pzas

MI 1 x 5 cm TI Serigrafía / Tampografía Láser

Repuesto disponible en tinta azul

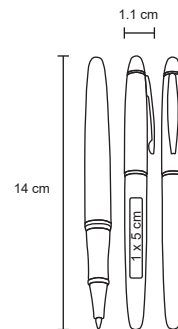

ABENDU

FM 8593

Bolígrafo metálico y mecanismo retráctil. Incluye estuche.

MT Metal M 1 x 14 cm E 150 Pzas. MI 0.7 x 3.5 cm TI Serigrafía / Láser / Tampografía

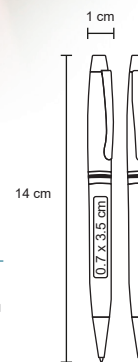

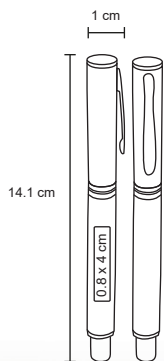

DALEZZO

FM 8592

Bolígrafo metálico roller con estuche de cierre magnético.

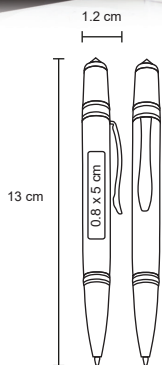

ACUARIO

FM 8266

Bolígrafo de aluminio con mecanismo retráctil.





CHAK

FM 0575

NUEVO

Bolígrafo metálico con clip, detalles en color plata en el cuerpo y mecanismo retráctil.

- MT Metal
- M 1 x 14,5 cm
- E 150 Pzas.
- MI 0,8 x 3 cm
- TI Tampografía / Láser / Serigrafía

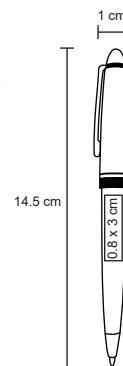

BOSCO

FM 7554

Bolígrafo metálico con mecanismo retráctil. Incluye estuche.

- MT Metal
- M 1 x 13,5 cm
- E 150 Pzas.
- MI 0,8 x 4 cm
- TI Serigrafía / Láser / Tampografía

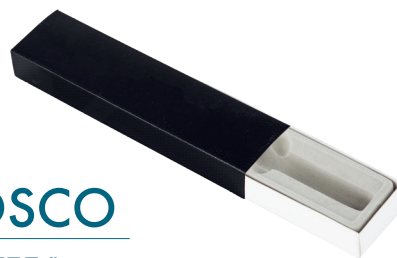
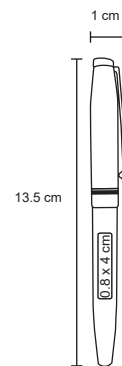

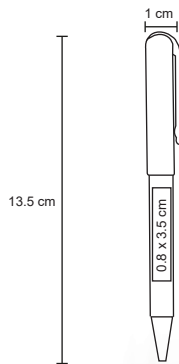

AKRON

NUEVO

Acabado
Rubber

AL 19008

Bolígrafo metálico en acabado rubber con clip y punta metálica, con mecanismo retráctil.

- MT Metal / Rubber
- M 1 x 13.5 cm
- E 250 Pzas.
- MI 0.8 x 3.5 cm
- TI Láser / Tampografía

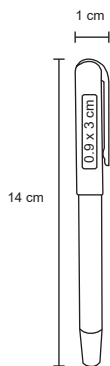

LASKA

FM 7555

Bolígrafo metálico con mecanismo retráctil. Incluye estuche.

- MT Metal
- M 1 x 14 cm
- E 150 Pzas.
- MI 0.9 x 3 cm
- TI Serigrafía / Láser / Tampografía





TABOR

FM 0574



Bolígrafo de aluminio con clip y detalles en color con mecanismo retráctil.

- MT Aluminio
- M 0.8 x 13.8 cm
- E 150 Pzas.
- MI 0.6 x 3.5 cm
- TI Tampografía / Láser / Serigrafía

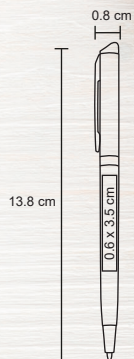

PISA

FM 0572



Bolígrafo de aluminio con clip y mecanismo retráctil.

- MT Aluminio
- M 0.8 x 13 cm
- E 150 Pzas.
- MI 0.6 x 4 cm
- TI Tampografía / Láser / Serigrafía

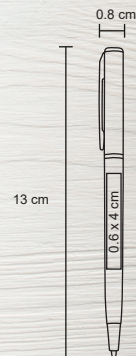



CAMERUN

FM 0571

NUEVO

Bolígrafo metálico con clip y detalles en dorado.

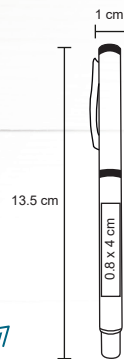

MT Metal
 M 1 x 13.5 cm
 E 150 Pzas.
 MI 0.8 x 4 cm
 TI Tampografía / Láser / Serigrafía

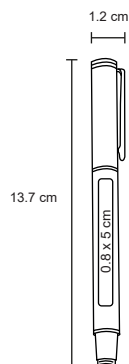

MÓNACO

FM 266

Bolígrafo metálico roller. Incluye estuche.



MT Metal
 M 12 x 13.7 cm
 E 250 Pzas
 MI 0.8 x 5 cm
 TI Serigrafía / Tampografía Láser